

Uniclass L5:P2:N32	EPIC E:X2:Y421
Cl/SfB	Rf9 (K2)+(K3)



# Promat SUPALUX<sup>®</sup>

*A High Performance, Non-Combustible Fire Protection Board*



applications guide

## Promat SUPALUX® – Applications Overview

The below list includes common applications using Promat SUPALUX®. For applications with fire ratings listed in **BLUE**, please refer to the latest version of the Promat UK Fire Protection Handbook or contact Promat Technical Services Department on 01344 381400.

### HOW TO USE THIS APPLICATIONS GUIDE

This Promat SUPALUX® Applications Guide is designed to provide examples of some of the most common applications of Promat SUPALUX® and does not provide detailed specifications for all applications.

The new handbook is available free on request. Call Promat on 01344 381350 to request a copy, or visit [www.promat.co.uk](http://www.promat.co.uk) to download a digital version.

Application Description	Fire Rating (minutes)	Page Number
<b>INTERNAL PARTITIONS</b>		
Timber Studs	30, 60, 90, 120	4
Steel Studs	30, 60, 90 120, 180, 240	6
Solid Partitions	30, 60, 90 120, 240	8
Shaftwall System	60, 120	9
<b>CEILINGS, FLOORS AND ROOFS</b>		
New Ceiling Lining	60, 90, 120	10
Fire from Above and Below	60	12
Upgrading Existing Ceiling from Below	60	12
Upgrading Existing Ceiling from Above	30, 60	13
Timber Roof Voids	30, 60, 120	14
Protection to Steel Beams, Concealed Grid System	60, 90, 120	15
Protection to Steel Beams, Exposed Grid System	30, 60	15
Membrane Ceiling	60, 120, 240	16
Timber Floors, Exposed Grid System	30, 60	17
Timber Floors, Concealed Grid System	60	18
Self-Supporting Ceiling Membranes	60, 120	19
Protected Zones	90, 120, 240	22
Thatched Roofs	30, 60	-
<b>EXTERNAL AND INTERNAL WALLS</b>		
Conversion of External Wall to Internal Wall, Concealed Grid System	30, 60, 120	24
Conversion of External Wall to Internal Wall, Exposed Grid System	30, 60 120	24
External Walls, Further than 1m from the Relevant Boundary, Exposed Grid System	60, 120 240	25
External Walls, Further than 1m from the Relevant Boundary, Concealed Grid System	120, 240	-
External Walls, Within 1m from the Relevant Boundary	30, 60 120	25
Load Bearing External Wall System	30, 60	-
<b>OTHER APPLICATIONS</b>		
Soffits and Fascias	30, 60	-
Dormer cheeks	30, 60	-
Door Upgrades	20, 30	-
Service Enclosures	120, 240	-
Structural Steel	30, 60, 90, 120	-
Non-combustible Lining e.g. Boiler Backing	-	-
Windposts	60, 90, 120	-



## Promat SUPALUX® Introduction

---

Promat SUPALUX® is a strong, lightweight, non-combustible building board which is fully certified for constructions offering up to 240 minutes fire resistance.

### FIRE PERFORMANCE

- Up to 240 minutes fire resistance.
- Non-combustible.
- Class 0 Buildings Regulations classification.
- Over 30 years of proven and tested performance.

### MOISTURE RESISTANCE

- Promat SUPALUX® retains its excellent dimensional stability even in damp and humid conditions and can be installed at an early stage in the construction programme, before wet trades are completed and the building is weather-tight.

### IMPACT RESISTANCE

- Promat SUPALUX® has good impact resistance making it suitable for most industrial applications.

### BIOLOGICAL AND CHEMICAL RESISTANCE

- Promat SUPALUX® is resistant to mould growth, most chemicals and attack by rodents and insects.

### EASY TO WORK, FIX AND DECORATE

- Promat SUPALUX® is easy to cut, drill, shape and can be worked in the same way as timber products with no special tools required.

### ENVIRONMENTAL

- Water used in manufacturing is re-circulated in a closed system and in-process waste material can be recycled.

### HEALTH AND SAFETY

- Promat SUPALUX® is not classified as a dangerous substance and can be placed in an on-site skip with other general building waste.

### CERTIFICATION

- Fire specifications backed by independent test, assessment or third party certification, ie Certifire.



## Promat SUPALUX® Internal Partitions

Timber Studs, 60 minutes

### HOW TO USE THIS APPLICATIONS GUIDE

The following Promat SUPALUX® Applications (pages 4 to 25) focus primarily on 60 minute and 120 minute fire ratings. For details on additional fire ratings or other applications not included in this guide, please refer to the latest version of the Promat UK Fire Protection Handbook or contact Promat Technical Services Department on 01344 381400.

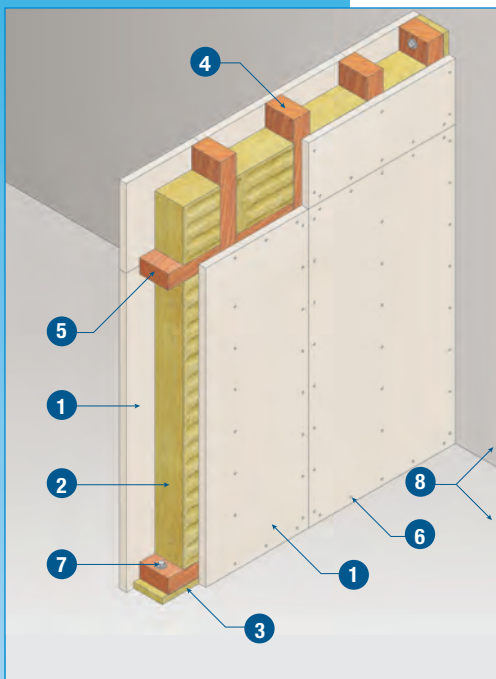

### TIMBER STUDS

#### TECHNICAL DATA

60 minutes fire rating, integrity and insulation in accordance with the criteria of BS 476: Part 22: 1987.

Nominal thickness of partition: 81mm

Maximum partition height: 4.0m

Estimated sound insulation: Rw 41dB

1. Promat SUPALUX® boards, each side 9mm thick. Boards are either butt jointed or flush jointed.
2. Rock wool, minimum 60mm thick x 23 kg/m<sup>3</sup>.
3. Rock wool seal or intumescent sealant.
4. Timber stud, 63mm x 50mm at maximum 610mm centres.
5. Timber noggings at horizontal board joints.
6. 50mm long round head nails or M4 x 50mm screws at nominal 300mm centres.
7. M6 steel anchor bolt at nominal 600mm centres.
8. Concrete wall or floor slab.



# Promat SUPALUX® Internal Partitions

Timber Studs, 120 minutes

Certifire Approval No CF 420A

## TIMBER STUDS

### TECHNICAL DATA

120 minutes fire rating, integrity and insulation in accordance with the criteria of BS 476: Part 22: 1987.

Nominal thickness of partition: 119mm

Maximum partition height: 4.0m

Estimated sound insulation: Rw 47dB

1. Promat SUPALUX® boards, each side 15mm thick. Boards are either butt jointed or flush jointed.
2. Rock wool, minimum 80mm thick x 100 kg/m<sup>3</sup> applied in 2 layers of 40mm thickness with all joints staggered by minimum 150mm between layers.
3. Rock wool seal, or intumescent sealant.
4. Timber stud, 89mm x 50mm at maximum 610mm centres.
5. Timber nogging at horizontal board joints.
6. 63mm long round head nails at nominal 200mm centres or M4 x 63mm screws at nominal 300mm centres.
7. M6 steel anchor bolt at nominal 600mm centres.
8. Concrete wall or floor slab

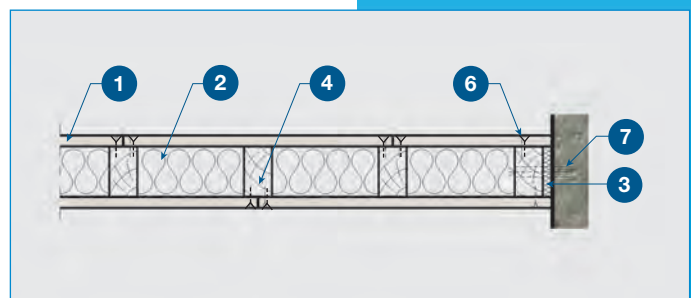
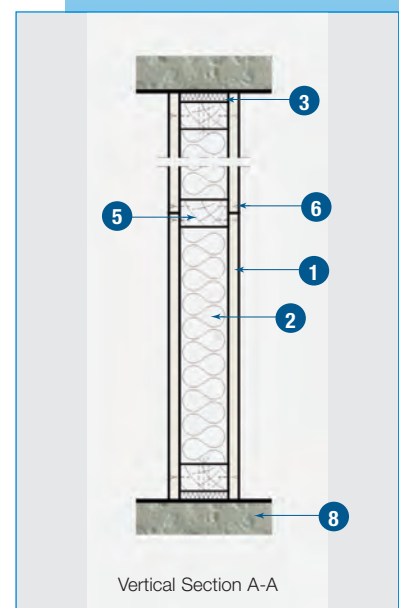
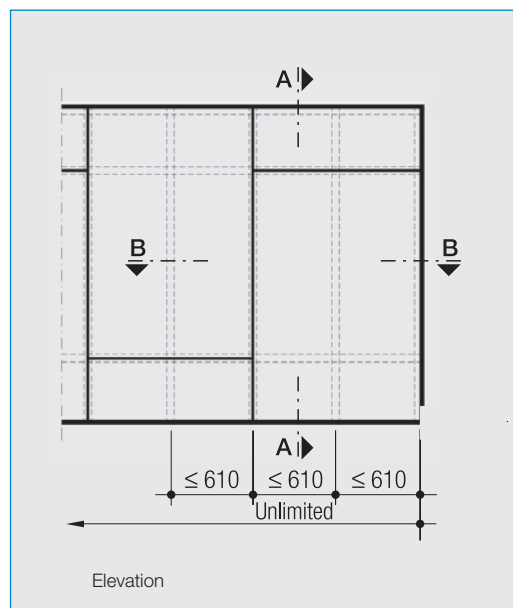
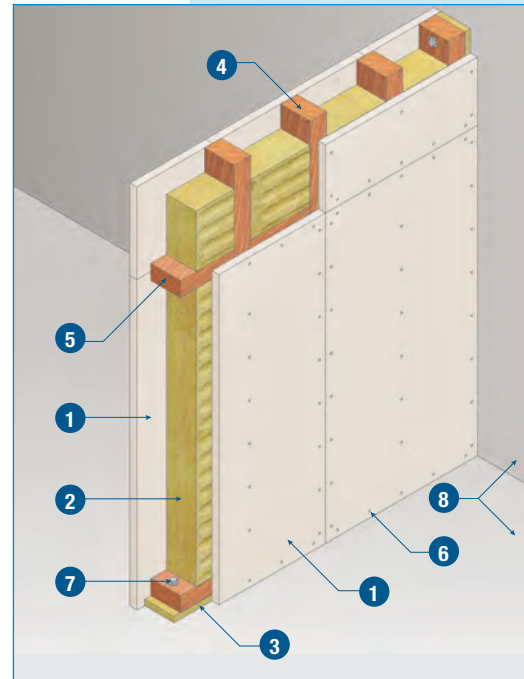

## Promat SUPALUX® Internal Partitions

Certifire Approval No CF 420A

Steel Studs, 60 minutes

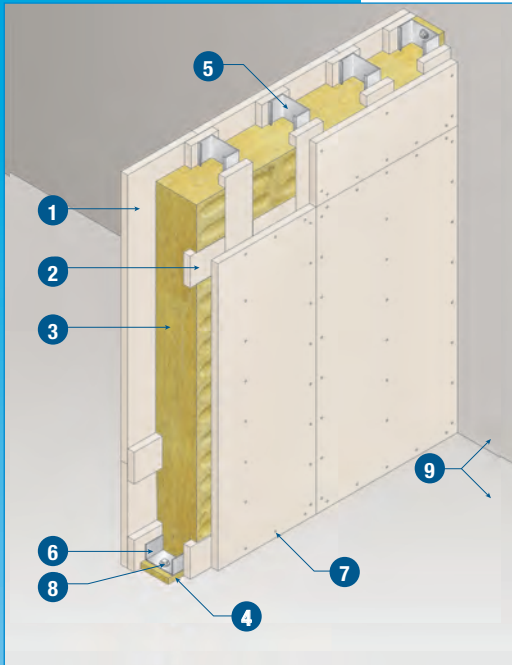

### STEEL STUDS TECHNICAL DATA

60 minutes fire rating, integrity and insulation in accordance with the criteria of BS 476: Part 22: 1987.

Nominal thickness of partition: 78mm

Estimated sound insulation: RW 44dB

1. Promat SUPALUX® boards, each side 9mm thick. Boards are either butt jointed or flush jointed.
2. Promat SUPALUX® fillet/coverstrip, 50mm wide, each side 6mm thick over studs and at horizontal board joints. Coverstrips at horizontal board joints fastened using M4 x 16mm long self-tapping screws at 300mm centres on both sides of the joint.
3. Rock wool, minimum 60mm thick x 23 kg/m<sup>3</sup>, or 50mm thick x 40kg/m<sup>3</sup>.
4. Rock wool seal or intumescent sealant.
5. Steel stud, 48mm x 32/34mm x 0.5mm, at maximum 610mm centres.
6. Ceiling and floor steel channel, 50mm x 25mm x 0.5mm.
7. M4 x 25mm self-tapping screws at nominal 300mm centres.
8. M6 steel anchor bolt at nominal 600mm centres.
9. Concrete wall or floor slab.

**NOTE:** The above partition specification is approved for heights up to 3m using framing members as detailed. Alternative specifications are available for heights up to 10m.

Contact Promat UK Technical Services Department for further details or refer to Certifire Certificate of Approval No. CF 420A.

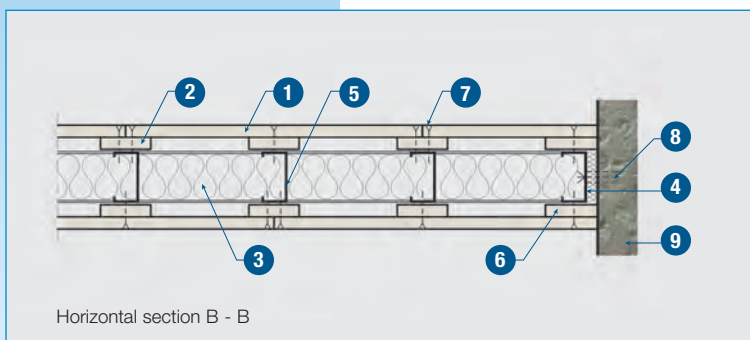
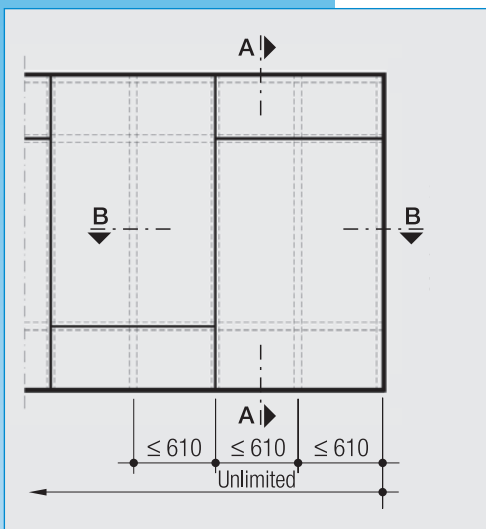



# Promat SUPALUX® Internal Partitions

Steel Studs, 120 minutes

Certifire Approval No CF 420A

## STEEL STUDS

### TECHNICAL DATA

120 minutes fire rating, integrity and insulation in accordance with the criteria of BS 476: Part 22: 1987.

Nominal thickness of partition: 104mm

Estimated sound insulation: Rw 48dB

1. Promat SUPALUX® boards, each side 15mm thick. Boards can be either butt jointed or flush jointed. No fillets required on vertical studs, coverstrips required behind horizontal board joints.
2. Promat SUPALUX® coverstrips, 100mm wide, each side 9mm thick. Fixed using M4 x 25mm self-tapping screws at 300mm centres on both sides of joint.
3. Rock wool, minimum 70mm thick x 128kg/m<sup>3</sup> applied in 2 layers with all joints staggered between layers by minimum 150mm.
4. Steel stud, 73.8mm x 47/49mm x 0.6mm, at maximum 610mm centres.
5. Ceiling and floor steel channel, 75mm x 40mm x 0.6mm.
6. M4 x 32mm self-tapping screws at nominal 300mm centres.
7. M6 steel anchor bolt at nominal 600mm centres.
8. Concrete wall or floor slab.

**NOTE:** The above partition specification is approved for heights up to 3m using framing members as detailed. Alternative specifications are available for heights up to 10m. Contact Promat UK Technical Services Department for further details or refer to Certifire Certificate of Approval No. CF 420A.

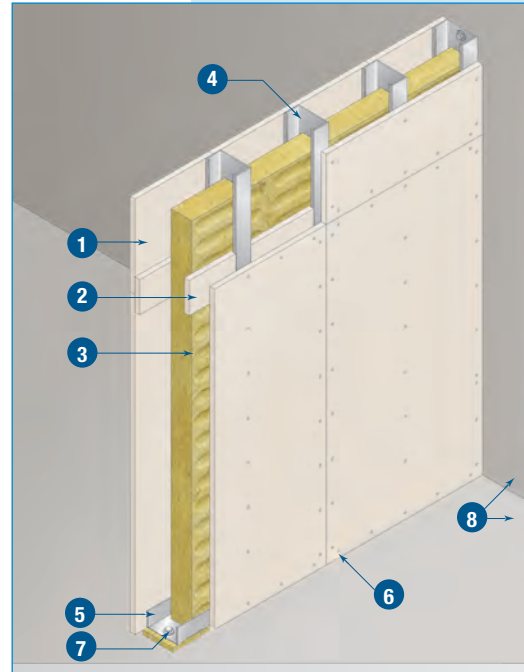

## TECHNICAL DATA

120 minutes rating for integrity only in accordance with the relevant criteria of BS 476: Part 22: 1987.

Nominal thickness of partition: 66mm

Estimated sound insulation: Rw 29dB

1. Promat SUPALUX® boards, 9mm thick, to fire risk side.
2. Promat SUPALUX® fillets, 75mm wide x 9mm thick. Fastened to steel framework with M4 x 25mm self-tapping screws at convenient centres.
3. Horizontal board joints backed with Promat SUPALUX® coverstrip 75mm wide x 9mm thick. Fastened using M4 x 25mm long self-tapping screws at nominal 300mm centres.
4. Steel stud, 48mm x 32/34mm x 0.5mm, at maximum 610mm centres.
5. Ceiling and floor steel channel, minimum 50mm x 25mm x 0.5mm.
6. M4 x 25mm self-tapping screws at nominal 300mm centres.
7. Rock wool seal or intumescent sealant.
8. M6 steel anchor bolt at nominal 600mm centres.
9. Concrete wall or floor slab.

**NOTE:** The above partition specification is approved for heights up to 3m using framing members as detailed. Alternative specifications are available for heights up to 10m. Contact Promat UK Technical Services Department for further details or refer to Certifire Certificate of Approval No. CF 420A.

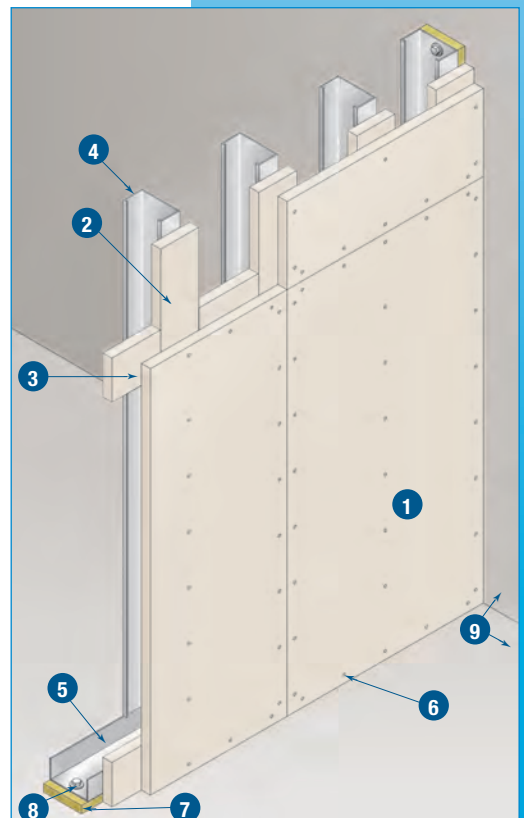

## Promat SUPALUX® Internal Partitions

Solid Partitions, 60 and 120 minutes

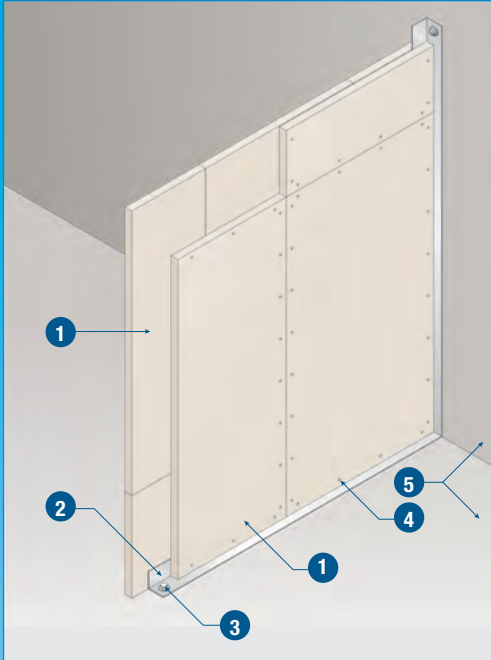

### SOLID PARTITIONS

#### TECHNICAL DATA

60 minutes fire rating, integrity and insulation in accordance with the criteria of BS 476: Part 22: 1987.

Nominal thickness of partition: 36mm

Estimated sound insulation: Rw 36dB

1. Promat SUPALUX® boards, 20mm + 15mm.  
Stagger joints by at least 600mm. Layers either sandwich the perimeter angle or are fastened to one face.
2. Steel angle frame, minimum 30mm x 30mm x 0.6mm bedded on Promat PROMASEAL® Intumescent Sealant.
3. M6 steel anchor bolt at nominal 500mm centres.
4. Self-tapping screws or similar. First layer 20mm, fixed to perimeter angle using M4 screws, at 300mm centres. Second layer 15mm, fixed to first layer using M4 x 30mm screws at 300mm centres around the perimeter and on both sides of each joint. Take care not to over tighten screws.
5. Concrete wall or floor slab.

**NOTE:** Maximum height of partition 5m.

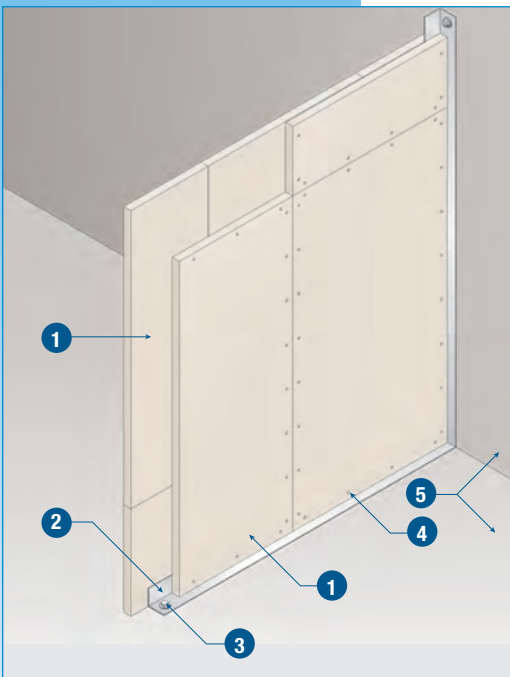

#### TECHNICAL DATA

120 minutes fire rating, integrity and insulation in accordance with the criteria of BS 476: Part 22: 1987.

Nominal thickness of partition: 51mm

Estimated sound insulation: Rw 37dB

1. Promat SUPALUX® boards, 2 x 25mm (Option A) or 20mm + 15mm + 15mm. (Option B) Stagger all joints by at least 600mm, between layers.  
  
Option A: The layers either sandwich the perimeter angles or are fastened to one side. The two layers of Promat SUPALUX® are fixed to the perimeter angles using M4 screws at 300mm centres. Edges of Promat SUPALUX® board fastened to opposite layer using M4 x 45mm steel self-tapping screws at nominal 300mm centres on both sides of each joint.  
Option B: Perimeter angle sandwiched between 20mm layer and the first 15mm layer. First layer 20mm, fixed to perimeter angle using M4 screws at 300mm centres. Second layer 15mm, fixed to first layer using M4 x 30mm screws at 300mm centres around the perimeter and on both sides of each joint. Third layer 15mm, fixed to first two layers using M4 x 45mm screws at 300mm centres around the perimeter and down the centre of each panel. Take care not to over tighten screws.
2. Steel angle frame, minimum 30mm x 30mm x 0.8mm bedded on Promat PROMASEAL® Intumescent Sealant.
3. M6 steel anchor bolt at nominal 500mm centres.
4. Steel self-tapping screws or similar.
5. Concrete wall or floor slab.

**NOTE:** Maximum height of partition 5m.



# Promat SUPALUX® Internal Partitions

## Shaftwall Partitions, 60 and 120 minutes

Certifire Approval No CF 420A

### INTERNAL PARTITIONS, SHAFTWALL SYSTEM

This system is applicable for use in those areas requiring integrity and insulation performance, but where access for construction is possible from one side only. e.g. lift shafts.

The system is designed for wall heights up to 7m (60 minutes) /6.4m (120 minutes).

#### TECHNICAL DATA

#### 60 minute and 120 minute fire rating in accordance with the criteria of BS 476: Part 22: 1987.

For the 120 minute construction the temperature of the exposed metal may exceed the requirements of BS 476: Part 22: 1987 within the fire test period and therefore relaxation should be sought from the authority on the basis that no combustible materials are likely to be stored adjacent to the structure.

1. Promat SUPALUX® boards, 9mm thick. Boards tightly fitted between studs and held in place with steel securing channels. Horizontal board joints backed by Promat SUPALUX® cover strip.
2. Steel channels, 85mm x 40mm x 1.2mm fixed back to back at maximum 300mm centres with M5 self-tapping screws to form "I" section and located at maximum 610mm centres.
3. Steel channels, 85mm x 40mm x 1.2mm fixed at edge of shaft wall partition at maximum 600mm centres with M6 steel anchor bolt.
4. Steel channels, 88mm x 40mm x 1.2mm bottom track fixed at maximum 600mm centres with M6 steel anchor bolt. All perimeter channels to be bedded with Promat PROMASEAL® Intumescent Sealant or bedded on rock wool.
5. Steel channels, 88mm x 70mm x 1.2mm head track fixed at maximum 600mm centres with M6 steel anchor bolt. All perimeter channels to be bedded with Promat PROMASEAL® Intumescent Sealant or bedded on rock wool (omitted from drawing).
6. Securing channel to be continuous steel channel 72mm x 25mm x 0.7mm fixed to steel web with M5 steel self-tapping screws at 300mm centres.
7. Promat SUPALUX® cover strip, 9mm thick x 100mm wide at all horizontal board joints, fastenened using M4 x 16mm self-tapping screws at nominal 200mm centres on both sides of joint.
8. **60 minute fire rating**  
– Rock wool, minimum 75mm thick x 45kg/m<sup>3</sup>
9. **120 minute fire rating**  
– Rock wool, minimum 75mm thick x 100kg/m<sup>3</sup>
10. **60 minute fire rating**  
– Promat SUPALUX® fillet, 20mm thick x 100mm wide fixed to steel channels with self-tapping or self drilling screws. 9mm Promat SUPALUX® board fixed to stud and perimeter channels through the fillets using M4 x 38mm self-tapping screws at 200mm nominal centres.
11. **120 minute fire rating**  
– Promat SUPALUX® fillet, 25mm thick x 100mm wide fixed to steel channels with self-tapping or self-drilling screws. 9mm Promat SUPALUX® board fixed to stud and perimeter channels through the fillets using M4 x 38mm self-tapping screws at 200mm nominal centres.

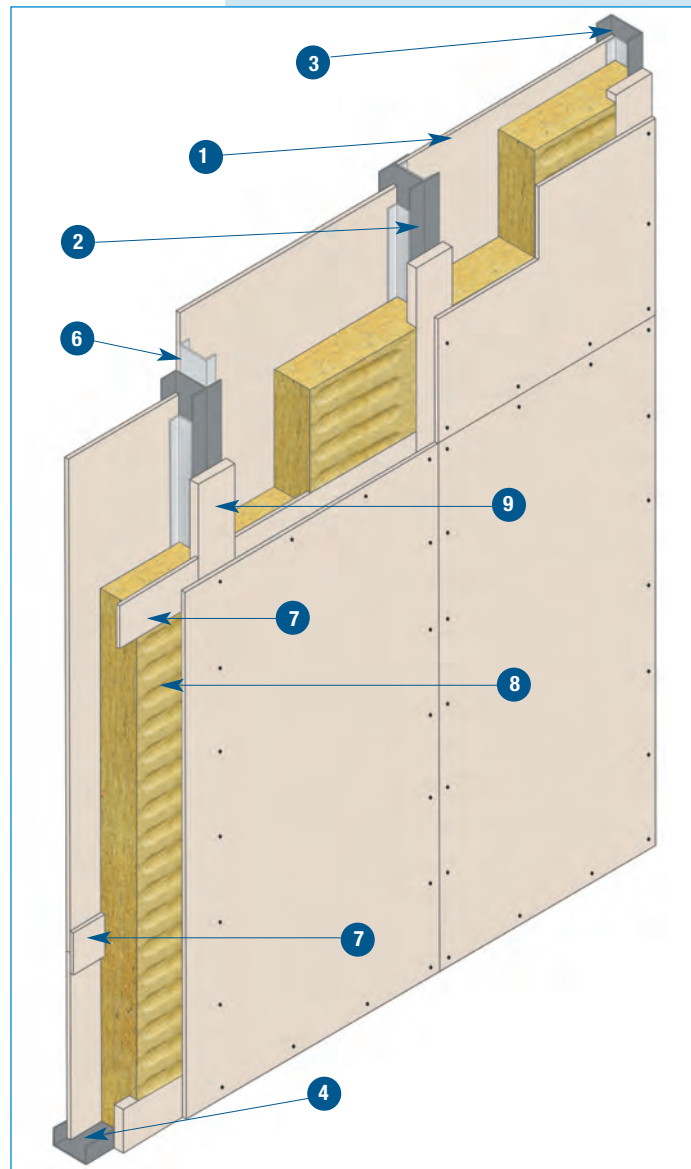

The construction is designed to fulfil the criteria of the relevant standards relating to the compartmentation of lift shafts and to provide resistance to positive and negative pressures resulting from the operation of lifts.

Estimated sound insulation:  
43-44dB (60 minute system)  
44-45dB (120 minute system)

#### NOTE:

Where Promat SUPALUX® is to be exposed to direct weathering during the building phase, impregnated Promat SUPALUX® is available.

## Promat SUPALUX® Ceilings, Floors and Roofs

Certifire Approval No CF 420

Ceiling Lining, 60 minutes

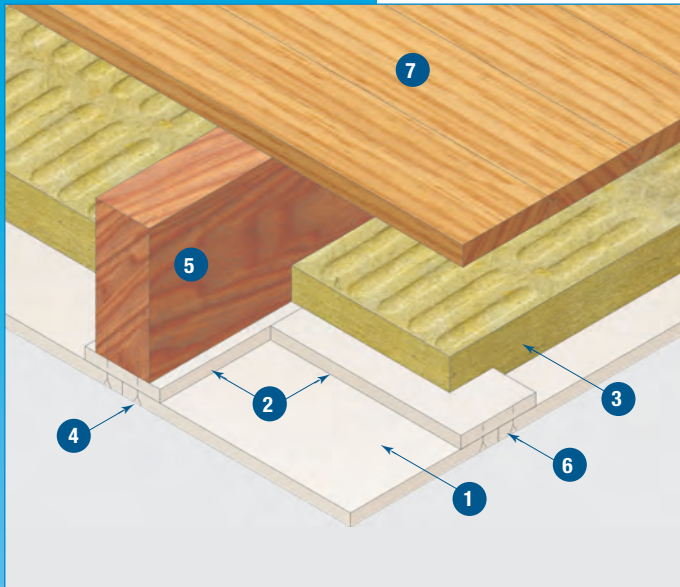

### NEW CEILING LINING

#### TECHNICAL DATA

60 minutes fire rating, loadbearing capacity, integrity and insulation in accordance with the criteria of BS 476: Part 21: 1987.

1. Promat SUPALUX® boards, 9mm thick.
2. Promat SUPALUX® fillet/coverstrip, 80mm x 9mm.
3. Rock wool, minimum 30mm x 60 kg/m<sup>3</sup> or 60mm x 23 kg/m<sup>3</sup>.
4. 75mm nails (with heads) at 200mm centres or M4 x 63mm long steel woodscrews at 300mm centres.
5. Timber joists, minimum 130mm x 38mm at maximum 610mm centres.
6. Cover strips at lateral board joints should be fastened using M4 x 25mm long self-tapping screws at nominal 300mm centres on both sides of joint.
7. T & G or square-edged flooring, minimum 19mm. Secure 4.8mm hardboard over square-edged floorboards.

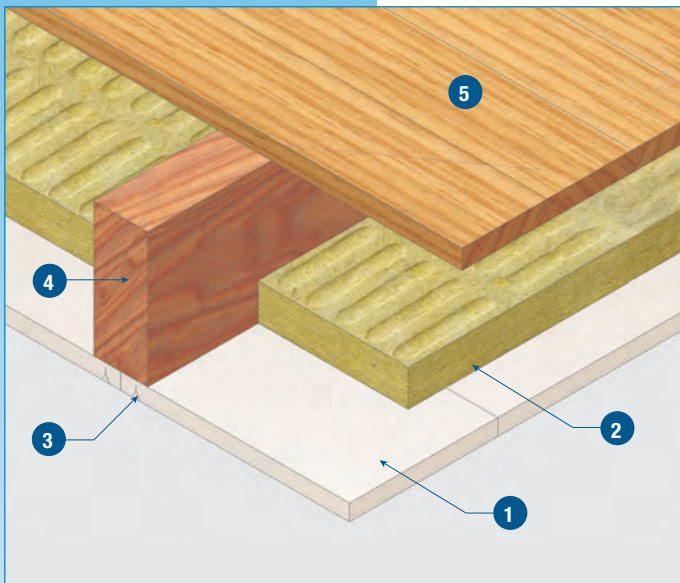

#### TECHNICAL DATA

60 minutes fire rating, loadbearing capacity, integrity and insulation in accordance with the criteria of BS 476: Part 21: 1987.

1. Promat SUPALUX® boards, 12mm thick.
2. Rock wool, minimum 30mm x 60 kg/m<sup>3</sup>.
3. 75mm nails (with heads) at 200mm centres or M4 x 63mm long steel woodscrews at 300mm centres.
4. Timber joists, minimum 150mm x 50mm at maximum 610mm centres.
5. T & G or square-edged flooring, minimum 19mm. Secure 4.8mm hardboard over square-edged floorboards.

The construction, maximum span and maximum loading on all timber floors should be accordance with BS 5268: Part 2.



# Promat SUPALUX® Ceilings, Floors and Roofs

Ceiling Lining, 60 minutes

Certifire Approval No CF 420

## NEW CEILING LINING

### TECHNICAL DATA

60 minutes fire rating, loadbearing capacity, integrity and insulation in accordance with the criteria of BS 476: Part 21: 1987.

1. Promat SUPALUX® boards, 9mm thick.
2. T & G or square-edged flooring, minimum 19mm. Secure 4.8mm hardboard over square-edged floorboards.
3. Steel angle, 30mm x 30mm x 0.8mm fastened to sides of joists with M4 x 32mm long steel woodscrews at 300mm nominal centres.
4. Rock wool, is required within the cavity, tightly wrapped to sides of joists. Thickness and density of rock wool depends on floor specification. Please contact Promat Technical Services Department for details.
5. Timber joists are of such dimensions that the residual timber at the end of the 60 minute fire exposure period will be sufficient to maintain the loadbearing capacity in accordance with BS 5268: Part 4: Section 4.1. For suitable flooring specifications, please contact Promat Technical Services Department for details.

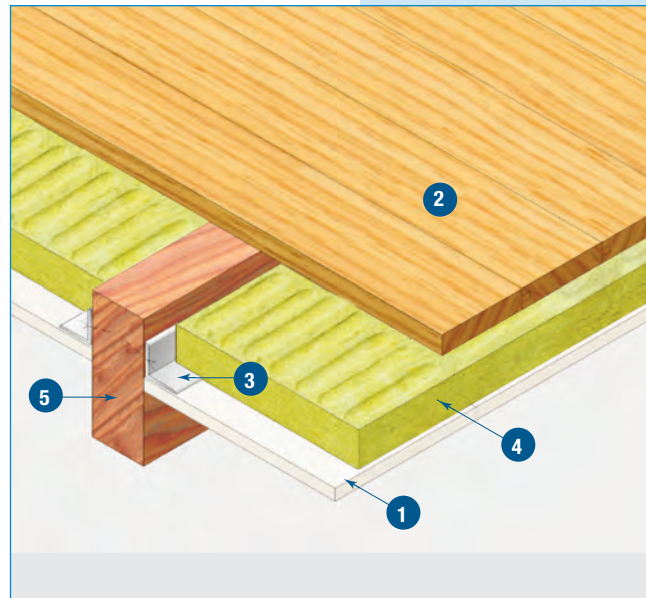

The construction, maximum span and maximum loading on all timber floors should be accordance with BS 5268: Part 2.

## Promat SUPALUX® Ceilings, Floors and Roofs

Certifire Approval No CF 420

Fire from Above and Below/Upgrading Existing Ceiling from Below, 60 minutes

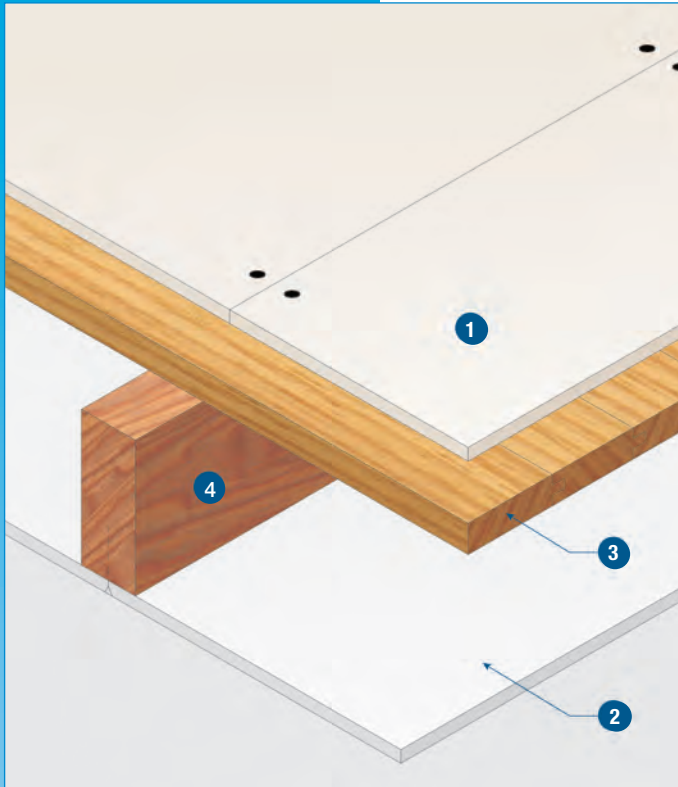

### FIRE FROM ABOVE AND BELOW

#### TECHNICAL DATA

60 minutes fire rating, loadbearing capacity, integrity and insulation in accordance with the criteria of BS 476: Part 21: 1987.

1. Promat SUPALUX® boards, 9mm thick. Edges of boards fastened to the flooring with M4 x 32mm long steel woodscrews at 400mm centres.
2. Promat SUPALUX® ceiling specification (direct fix) suitable to provide 60 minutes fire protection from below.
3. Softwood T & G or square edged flooring, minimum 22mm thick. Secure 4.8mm hardboard over square edged floorboards.
4. Timber joists, minimum 130mm x 38mm at maximum 610mm centres.

**NOTE:** Additional flooring material may be required according to the impact and load bearing requirements.

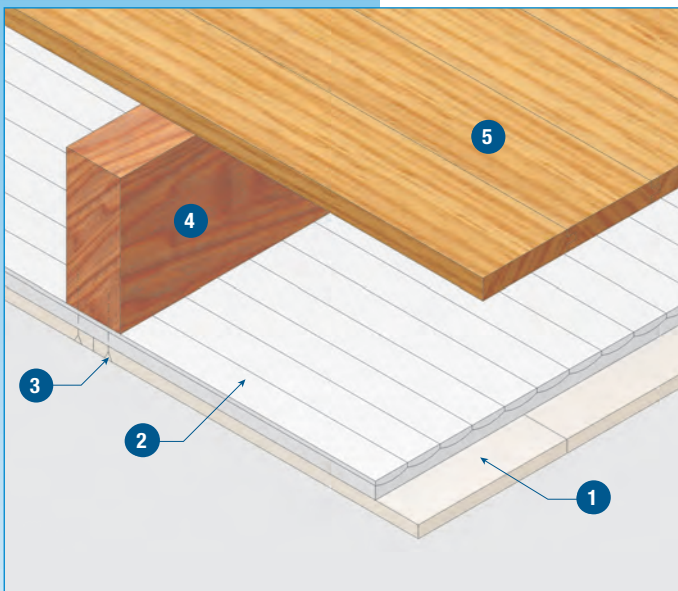

### UPGRADING EXISTING CEILING FROM BELOW

#### TECHNICAL DATA

60 minutes fire rating, loadbearing capacity, integrity and insulation in accordance with the criteria of BS 476: Part 21: 1987.

1. Promat SUPALUX® boards, 12mm thick.
2. Either 9.5mm gypsum wallboard or lath and plaster. If lath and plaster, it is normally advisable to underline the existing ceiling with chicken wire mesh and timber battens before securing Promat SUPALUX®.
3. M4 woodscrews at 300mm centres to each joist, select screw length to provide at least 50mm penetration into the timber joist.
4. Timber joists, minimum 150mm x 50mm at maximum 610mm centres.
5. T & G or square-edged flooring, minimum 22mm thick. Secure 4.8mm hardboard over square-edged floorboards.

The construction, maximum span and maximum loading on all timber floors should be in accordance with BS 5268: Part 2.



## Promat SUPALUX® Ceilings, Floors and Roofs

### Upgrading Existing Ceiling from Above, 60 minutes

Certifire Approval No CF 420

#### UPGRADING EXISTING CEILING FROM ABOVE

##### TECHNICAL DATA

60 minutes fire rating, loadbearing capacity, integrity and insulation in accordance with the criteria of BS 476: Part 21: 1987.

1. Promat SUPALUX® boards, 12mm thick laid on top of supporting strips between joists.
2. 2 x Promat SUPALUX® support strips, each minimum 75mm deep x 12mm thick secured to sides of joists using M4 x 62mm long steel screws at 300mm centres. Ensure screws are located approximately 12mm from upper edge of support strips. The bottom edge of support strips should be in contact with ceiling.
3. Rock wool, minimum 80mm x 23 kg/m<sup>3</sup>, not required if existing ceiling is gypsum wallboard 12.5mm thick, in good condition.
4. Existing ceiling.
5. Timber joists, minimum 200mm x 75mm, at maximum 450mm centres.
6. T & G or square edged flooring, minimum 19mm thick.  
Secure 4.8mm hardboard over square edged floorboards.

**NOTE:** The specification is valid for applications where the fire risk is from below but where it is only possible to carry out work from above the floor.

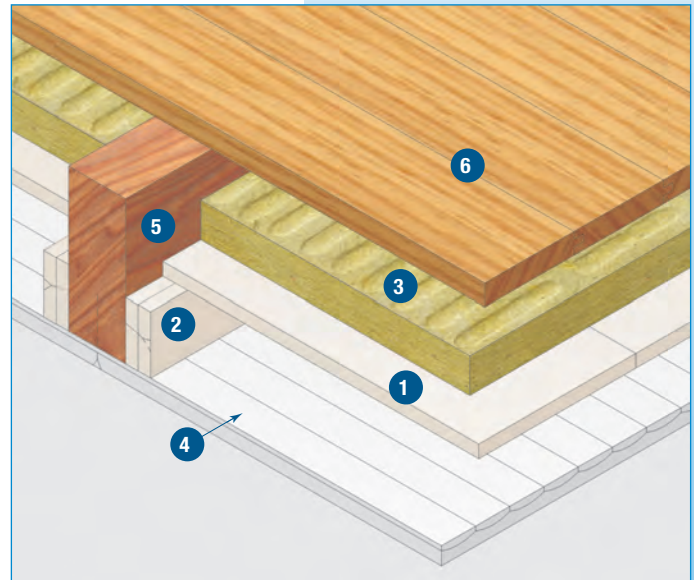

The construction, maximum span and maximum loading on all timber floors should be in accordance with BS 5268: Part 2.

## Promat SUPALUX® Ceilings, Floors and Roofs

Certifire Approval No CF 420

Timber Roof Voids, 60 minutes

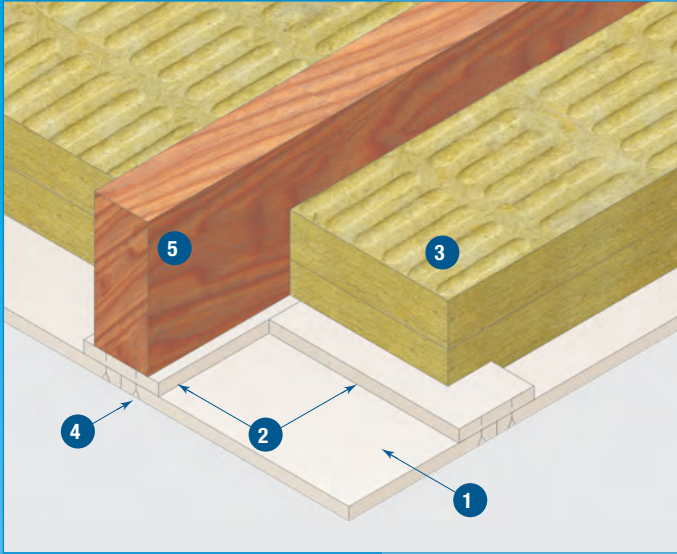

The construction, maximum span and maximum loading on all timber floors should be in accordance with BS 5268: Part 2.

### TIMBER ROOF VOIDS

#### TECHNICAL DATA

60 minutes fire rating, load bearing capacity, integrity and insulation in accordance with the criteria of BS 476: Part 21: 1987.

1. Promat SUPALUX® boards, 12mm thick.
2. Promat SUPALUX® fillet/coverstrip, 80mm wide x 12mm thick. Cover strips at lateral board joints fastened using M4 x 25mm long self-tapping screws at nominal 300mm centres on both sides of the joint.
3. Rock wool, minimum 2 x 60mm thick x 100kg/m<sup>3</sup>.
4. M4 x 75mm long steel woodscrews at 300mm centres.
5. Timber joists, minimum 145mm deep x 35mm wide at maximum 610mm centres.

**NOTE:** For 72mm, 97mm and 120mm deep joists, 2 x 80mm wide x 12mm thick Promat SUPALUX® fillets are required to the underside of the joists.



# Promat SUPALUX® Ceilings, Floors and Roofs

Protection to Steel Beams, Concealed and Exposed Grid, 60 minutes

Certifire Approval No CF 420

## PROTECTION TO STEEL BEAMS, CONCEALED GRID SYSTEM

### TECHNICAL DATA

Protection to steel beams supporting concrete floor - 60 minutes fire rating, loadbearing capacity (for steel beams above) in accordance with the criteria of BS 476: Part 23: 1987

1. Promat SUPALUX® boards, 9mm thick (square or bevelled edge).
2. Promat SUPALUX® fillet, 75mm wide, 9mm thick.
3. No rock wool required.
4. Fire rated ceiling channel section, minimum 60mm x 27mm x 0.5mm at 610mm centres (primary channels are lipped).
5. Fillets fixed to underside of primary and cross channels and perimeter angle using M4 x 25mm long steel self-tapping screws at any convenient centres. Promat SUPALUX® boards fixed through fillets to channels and perimeter angle with M4 x 32mm long steel self-tapping screws at nominal 300mm centres.
6. Rigid hangers at 1000mm centres (fixed to steel beam or concrete soffit).
7. Structural steel beam.
8. Concrete floor slab.

Perimeter steel angles 50mm x 50mm x 0.7mm thick are fastened at nominal 400mm centres to the concrete or masonry surrounding structure using minimum M4 x 32mm long steel screws into non-combustible plugs or equivalent.

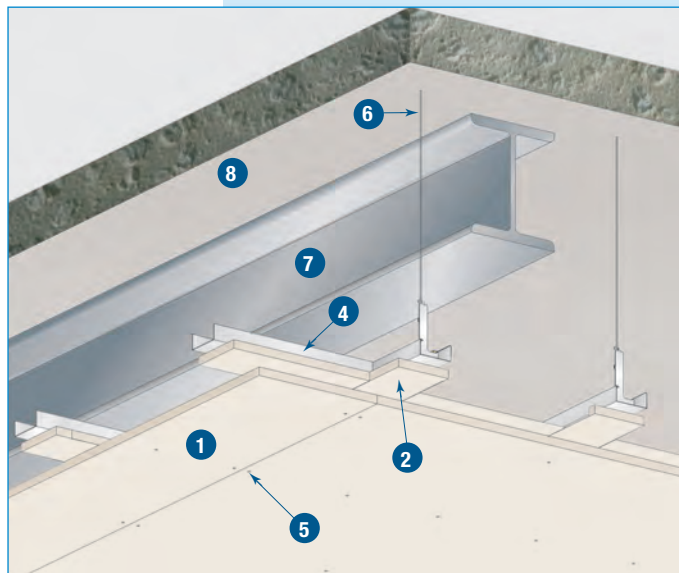

## PROTECTION TO STEEL BEAMS, EXPOSED GRID SYSTEM

### TECHNICAL DATA

Protection to steel beams supporting concrete floor - 60 minutes fire rating, loadbearing capacity (for steel beams above) in accordance with the criteria of BS 476: Part 23: 1987.

1. Promat SUPALUX® ceiling panels, 6mm thick by 1200mm x 600mm or 600mm x 600mm nominal, located at least 200mm from underside of steel beam.
2. Fire rated exposed grid tee system (minimum table width of 24mm) main tees at 1200mm or 600mm centres. Panels are fixed using steel hold down clips – 3 along each 1200mm edge and one at the centre of a 600mm edge.  
Perimeter steel angles with minimum 32mm wide horizontal leg and 19mm wide vertical leg and between 0.5 and 0.8mm thick, should be fastened using M4 x 32mm long steel self-tapping screws into non-combustible plugs or equivalent at nominal 400mm centres to the concrete or masonry surrounding structure.
3. Galvanised steel wire hangers (minimum 2mm diameter) at maximum 1220mm centres, fixed to beams using steel flange clips. Alternatively fixed to concrete slab using suitable fire-rated all-steel ring or hook anchors, minimum 5mm diameter.
4. Rock wool minimum 30mm x 60kg/m³ density.
5. Structural steel beam.
6. Concrete floor slab.

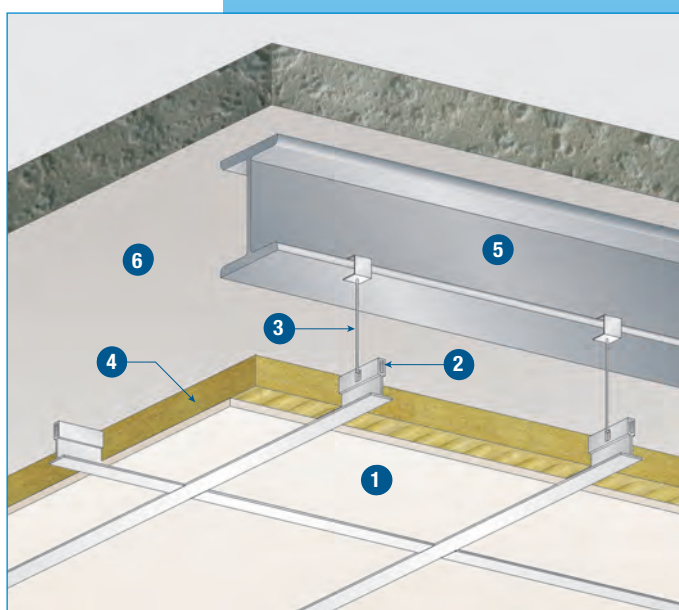

## Promat SUPALUX® Ceilings, Floors and Roofs

Certifire Approval No CF 420

Membrane Ceilings, 60 minutes

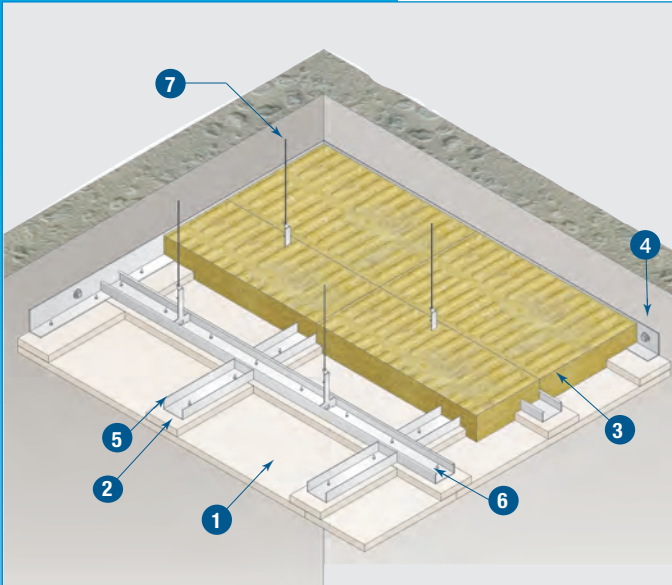

### MEMBRANE CEILING

#### TECHNICAL DATA

60 minutes fire rating, integrity and insulation in accordance with the criteria of BS 476: Part 22: 1987 with fire from above or below.

1. Promat SUPALUX® boards, 9mm thick (square or bevelled edge).
2. Promat SUPALUX® fillet, 75mm wide, 9mm thick.
3. Two layers of rock wool, each a minimum 50mm x 60kg/m<sup>3</sup> or 60mm x 45kg/m<sup>3</sup>. Joints should be staggered 300mm between layers.
4. Perimeter steel angles minimum 50mm x 50mm x 0.7mm thick fastened using M4 x 32mm long steel self-tapping screws into non-combustible plugs or equivalent at nominal 400mm centres (through the 25mm leg) to the concrete or masonry surrounding structure.
5. Fire rated concealed channel system ceiling channel section minimum 60mm wide x 27mm deep x 0.5mm steel thickness. Primary channels are lipped channels. Primary channels positioned at nominal 600mm centres. Cross channels positioned between primary channels at board joints and connected to primary channels using interlocking steel connectors.
6. Fillet fixed to underside of primary and cross channels and perimeter angle with M4 x 25mm long steel self-tapping screws at any convenient centres. Promat SUPALUX® boards fixed through fillets to channels and perimeter angle with M4 x 32mm long steel self-tapping screws at nominal 300mm centres.
7. Hanger rod at 1000mm centres, tensile stress on hanger should not exceed 15N/mm<sup>2</sup> (for fire exposure from above). Please consult Promat Technical Services Department for details of fixing hanger rods to structural soffit.

#### NOTE:

Maximum panel size for square edge: 2440mm x 1220mm

Maximum panel size for bevel edge: 1220mm x 1220mm



# Promat SUPALUX® Ceilings, Floors and Roofs

Timber Floors, Exposed Grid, 60 minutes

Certifire Approval No CF 420

## TIMBER FLOORS, EXPOSED GRID SYSTEM

### TECHNICAL DATA

60 minutes fire rating, loadbearing capacity, integrity and insulation in accordance with the criteria of BS 476: Part 21: 1987.

1. Promat SUPALUX® ceiling panels, 6mm thick by 1200mm x 600mm or 600mm x 600mm nominal, located at least 200mm from underside of joists.
2. Fire rated exposed grid tee system (minimum table width 24mm), main tees at maximum 610mm centres. Panels are fixed using steel hold down clips - 3 along each 1200mm edge and one at the centre of a 600mm edge. Perimeter steel angles with minimum 32mm wide horizontal leg and 19mm wide vertical leg and between 0.5 and 0.8mm thick, fastened at nominal 400mm centres to the concrete or masonry surrounding structure with minimum M4 x 32mm fixings.
3. Galvanised wire hangers, minimum 2mm diameter at maximum 1220mm centres. Secure hangers to sides of joists using 38mm nails or screws located at least 75mm above joist base.
4. Rock wool, minimum 30mm x 60 kg/m<sup>3</sup> fitted between tees.
5. Timber joists, minimum 150mm x 38mm at maximum 610mm centres.
6. T & G or square-edged flooring, minimum 19mm. Secure 4.8mm hardboard over square-edged floorboards.

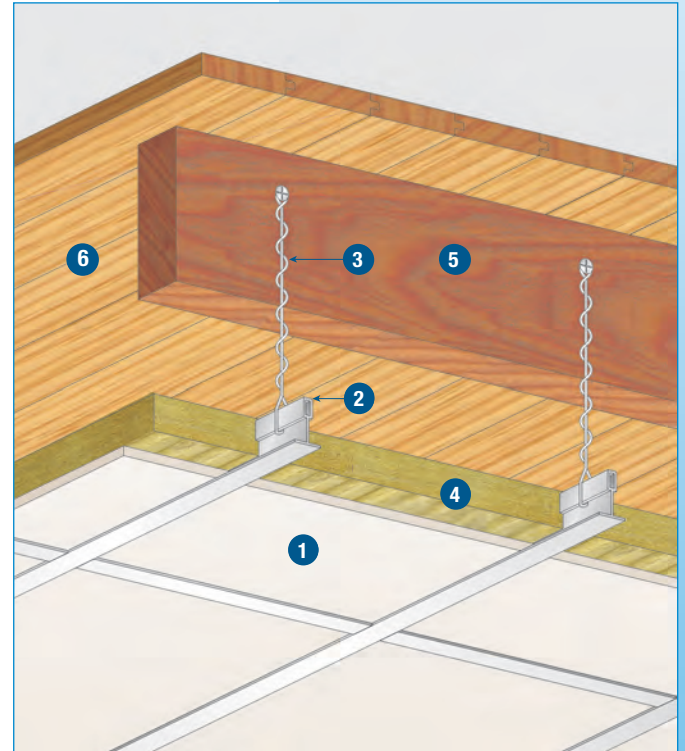

The construction, maximum span and maximum loading on all timber floors should be in accordance with BS 5268: Part 2.

## Promat SUPALUX® Ceilings, Floors and Roofs

Certifire Approval No CF 420

### Timber Floors, Concealed Grid, 60 minutes

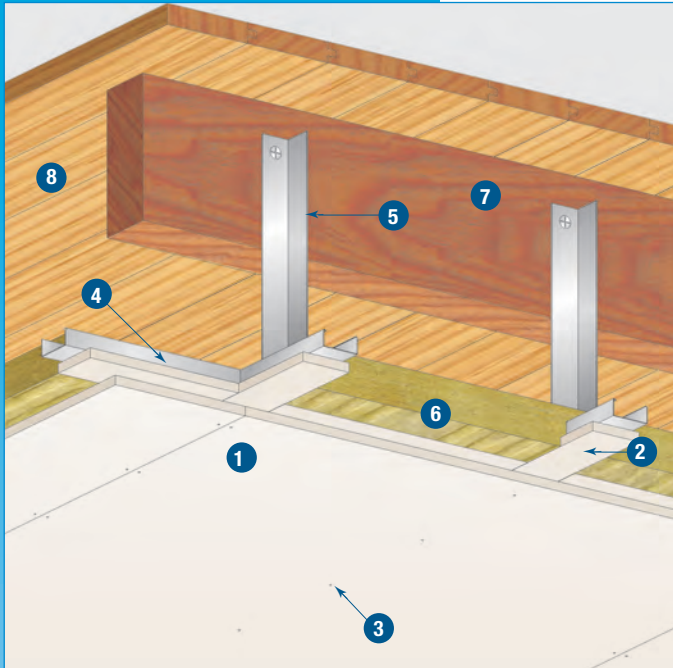

The construction, maximum span and maximum loading on all timber floors should be in accordance with BS 5268: Part 2.

### TIMBER FLOORS, CONCEALED GRID SYSTEM

#### TECHNICAL DATA

60 minutes fire rating, loadbearing capacity, integrity and insulation in accordance with the criteria of BS 476: Part 21: 1987.

1. Promat SUPALUX® 12mm panels (square or bevelled edge) to be located at least 200mm below underside of timber joists.
2. Promat SUPALUX® fillet, 75mm wide x 12mm thick.
3. Fillets fixed to underside of primary and cross channels and perimeter angle with M4 x 25mm long steel self-tapping screws at any convenient centres. Promat SUPALUX® boards fixed through fillets to channels and perimeter angles with M4 x 32mm long steel self-tapping screws at nominal 300mm centres.
4. Fire rated concealed channel system. Ceiling channel section minimum 60mm wide x 27mm deep x 0.5mm steel thickness. Primary channels are lipped channels. Primary channels positioned at maximum 610mm centres. Cross channels positioned between primary channels at board joints and connected to primary channels using interlocking steel connectors. Perimeter steel angles minimum 50mm x 50mm x 0.7mm thick fastened at nominal 400mm centres to the concrete or masonry surrounding structure with minimum M4 x 32mm long steel screws into non-combustible plugs or equivalent.
5. Rigid hangers at maximum 1220mm centres secured to sides of joists using 38mm nails or screws located at least 75mm above joist base.
6. Rock wool, minimum 50mm x 45 kg/m<sup>3</sup> laid over panels and grid members.
7. Timber joists, minimum 150mm x 38mm at maximum 610mm centres.
8. T & G or square-edged flooring, minimum 19mm. Secure 4.8mm hardboard over square-edged floorboards.

#### NOTE:

Maximum panel size for square edge: 2440mm x 1220mm

Maximum panel size for bevel edge: 1220mm x 1220mm



# Promat SUPALUX® Ceilings, Floors and Roofs

Self-Supporting Ceiling Membranes, 60 minutes

Certifire Approval No CF 420

## SELF-SUPPORTING CEILING MEMBRANES

### TECHNICAL DATA

60 minutes fire rating, integrity only; in accordance with the criteria of BS 476: Part 22: 1987 with fire from below.

1. Promat SUPALUX® boards, 9mm thick (square edged).
2. Promat SUPALUX® fillets, 75mm x 9mm thick.  
The thickness of Promat SUPALUX® fillets on underside of the perimeter angles may be reduced by 3mm to maintain an even surface for the main ceiling boards.
3. C-channel purlins (see table below) positioned at maximum 610mm centres. Expansion gap is left at both ends of the C channels.
4. Perimeter steel angle, nominally 75mm x 50mm, fastened to wall around perimeter of ceiling, through the 50mm leg, with minimum M6 x 50mm long all steel fixing anchors at 300mm nominal centres. See table below for angle thickness.
5. M4 x 38mm long self-tapping screws fixed at 200mm centres on facing board and M4 x 25mm long self-tapping screws at 500mm centres on fillets to channels and perimeter angles.
6. M6 x 50mm long steel expansion bolts at 300mm centres.
7. Concrete or brickwall.

Ceiling span m	C Channel purlin mm	Perimeter angle thickness mm	Expansion gap at each end mm
1.2	76 x 34 x 0.55	1.0	8
1.4	92 x 34 x 0.55	1.0	8
1.6	92 x 34 x 0.75	1.0	12
1.8	100 x 44 x 1.0	2.0	12
2.0	100 x 44 x 1.0	2.0	12
2.2	100 x 44 x 1.0	2.0	15
2.4	100 x 44 x 1.2	2.0	15
2.6	100 x 44 x 1.6	2.0	15
2.8	100 x 44 x 1.9	2.0	18
3.0	150 x 44 x 1.2	2.0	18
3.2	150 x 44 x 1.2	3.0	18
3.4	150 x 44 x 1.6	3.0	23
3.6	150 x 44 x 1.6	3.0	23
3.8	150 x 44 x 1.9	3.0	23
4.0	150 x 44 x 1.9	3.0	23

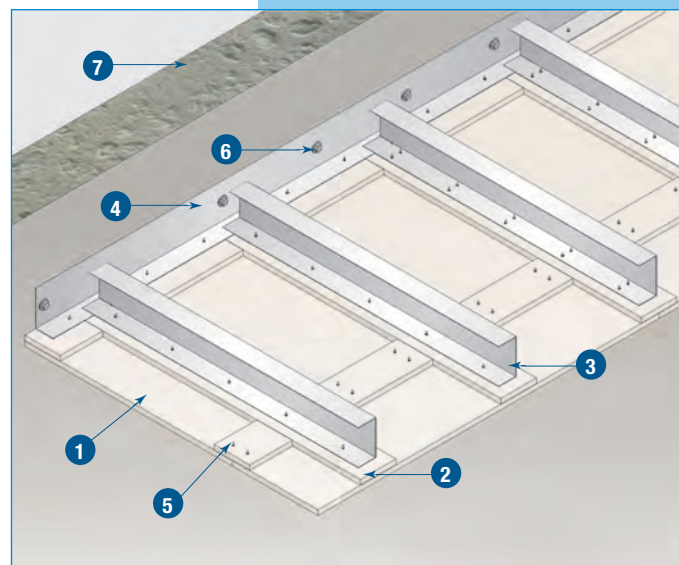
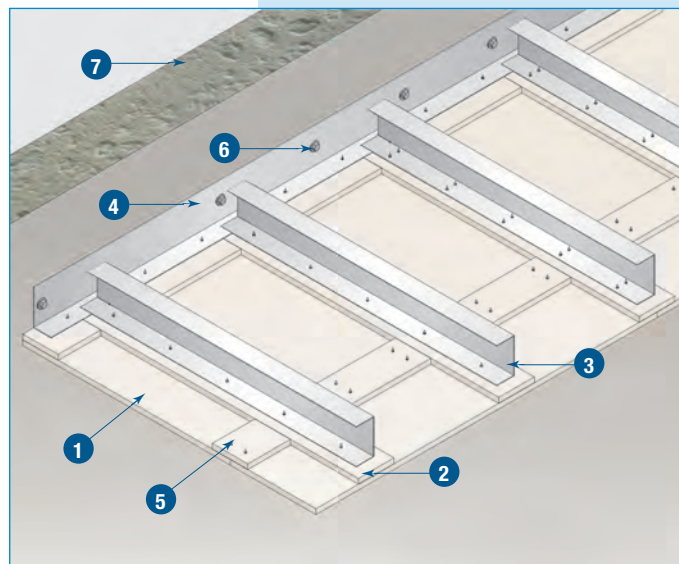

## Promat SUPALUX® Ceilings, Floors and Roofs

Certifire Approval No CF 420

### Self-Supporting Ceiling Membranes, 60 minutes

#### SELF-SUPPORTING CEILING MEMBRANES

##### TECHNICAL DATA

60 minutes fire rating, integrity only; in accordance with the criteria of BS 476: Part 22: 1987 with fire from above or below.

1. Promat SUPALUX® boards, 9mm thick (square edged).
2. Promat SUPALUX® fillets, 75mm x 9mm thick.  
The thickness of Promat SUPALUX® fillets on underside of the perimeter angles may be reduced by 3mm to maintain an even surface for the main ceiling boards.  
Lateral board joints backed by Promat SUPALUX® fillet fastened using M4 x 25mm long self-tapping screws at nominal 200mm centres on both sides of the joint.
3. C-channel purlins (see table below) positioned at maximum 610mm centres. Expansion gap is left at both ends of the C channels.
4. Perimeter steel angle, nominally 75mm x 50mm, fastened to wall around perimeter of ceiling, through the 50mm leg, with minimum M6 x 50mm long all steel fixing anchors at 300mm nominal centres. See table for angle thickness.
5. M4 x 38mm long self-tapping screws fixed at 200mm centres on facing board and M4 x 25mm self-tapping screws at 500mm centres on fillets to channels and perimeter angles.
6. M6 x 50mm long steel expansion bolts at 300mm centres.
7. Concrete or brickwall.

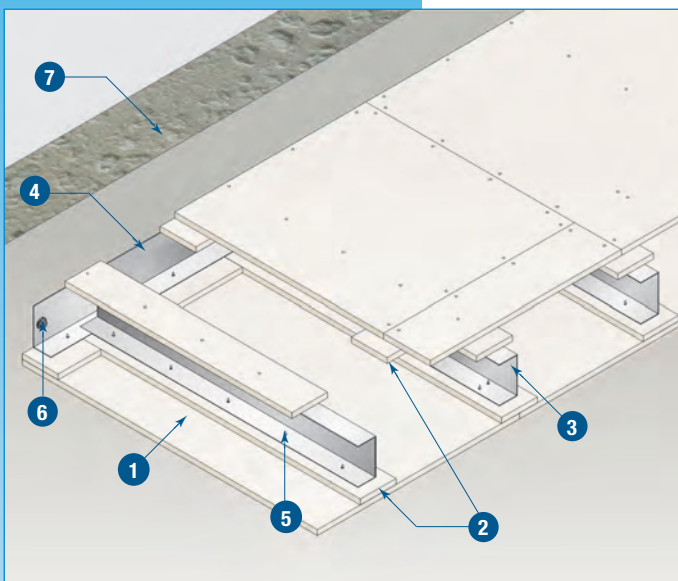
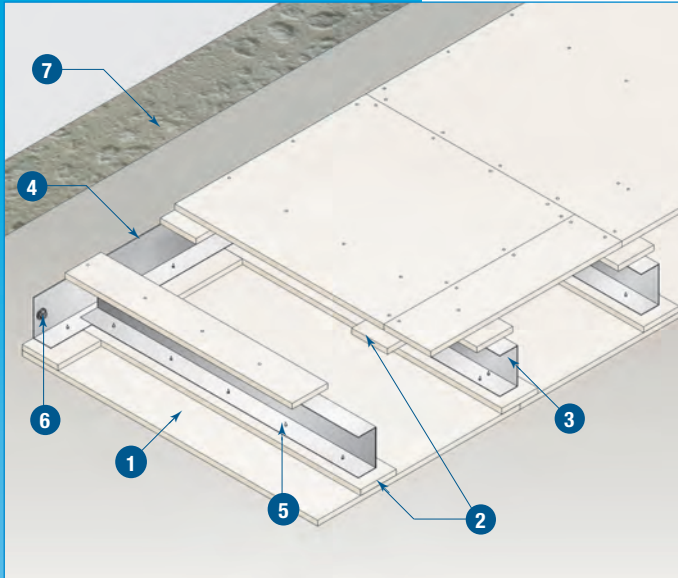

Ceiling span m	C Channel purlin mm	Perimeter angle thickness mm	Expansion gap at each end mm
1.2	76 x 34 x 0.55	1.0	8
1.4	92 x 34 x 0.55	1.0	8
1.6	92 x 34 x 0.75	1.0	12
1.8	100 x 44 x 1.0	2.0	12
2.0	100 x 44 x 1.0	2.0	12
2.2	100 x 44 x 1.0	2.0	15
2.4	100 x 44 x 1.2	2.0	15
2.6	100 x 44 x 1.6	2.0	15
2.8	100 x 44 x 1.9	2.0	18
3.0	150 x 44 x 1.2	2.0	18
3.2	150 x 44 x 1.2	3.0	18
3.4	150 x 44 x 1.6	3.0	23
3.6	150 x 44 x 1.6	3.0	23
3.8	150 x 44 x 1.9	3.0	23
4.0	150 x 44 x 1.9	3.0	23



# Promat SUPALUX® Ceilings, Floors and Roofs

Self-Supporting Ceiling Membranes, 60 minutes

Certifire Approval No CF 420

## SELF-SUPPORTING CEILING MEMBRANES

### TECHNICAL DATA

60 minutes fire rating, integrity and insulation in accordance with the criteria of BS 476: Part 22: 1987 with fire from above or below.

1. Promat SUPALUX® boards, 9mm thick (square edged).
2. Promat SUPALUX® fillets, 75mm x 9mm thick  
The thickness of Promat SUPALUX® fillets on underside of the perimeter angles may be reduced by 3mm to maintain an even surface for the main ceiling boards.  
Lateral board joints backed by Promat SUPALUX® fillet fastened using M4 x 25mm long self-tapping screws at nominal 200mm centres on both sides of the joint.
3. C-channel purlins (see table below) positioned at maximum 610mm centres. Expansion gap is left at both ends of the C channels.
4. Perimeter steel angle, nominally 75mm x 50mm, fastened to wall around perimeter of ceiling, through the 50mm leg, with minimum M6 x 50mm long all steel fixing anchors at 300mm nominal centres. See table below for angle thickness.
5. M4 x 38mm long self-tapping screws fixed at 200mm centres on facing board and M4 x 25mm long self-tapping screws at 500mm centres on coverstrip to purlins.
6. M6 x 50mm long steel expansion bolts at 300mm centres.
7. Concrete or brickwall.
8. Rock wool, minimum 2 x 50mm x 45kg/m<sup>3</sup> joints staggered by 300mm between layers.

Ceiling span m	C Channel purlin mm	Perimeter angle thickness mm	Expansion gap at each end mm
1.2	76 x 34 x 0.55	1.0	8
1.4	92 x 34 x 0.55	1.0	8
1.6	92 x 34 x 0.75	1.0	12
1.8	100 x 44 x 1.0	2.0	12
2.0	100 x 44 x 1.0	2.0	12
2.2	100 x 44 x 1.0	2.0	15
2.4	100 x 44 x 1.2	2.0	15
2.6	100 x 44 x 1.6	2.0	15
2.8	100 x 44 x 1.9	2.0	18
3.0	150 x 44 x 1.2	2.0	18
3.2	150 x 44 x 1.2	3.0	18
3.4	150 x 44 x 1.6	3.0	23
3.6	150 x 44 x 1.6	3.0	23
3.8	150 x 44 x 1.9	3.0	23
4.0	150 x 44 x 1.9	3.0	23

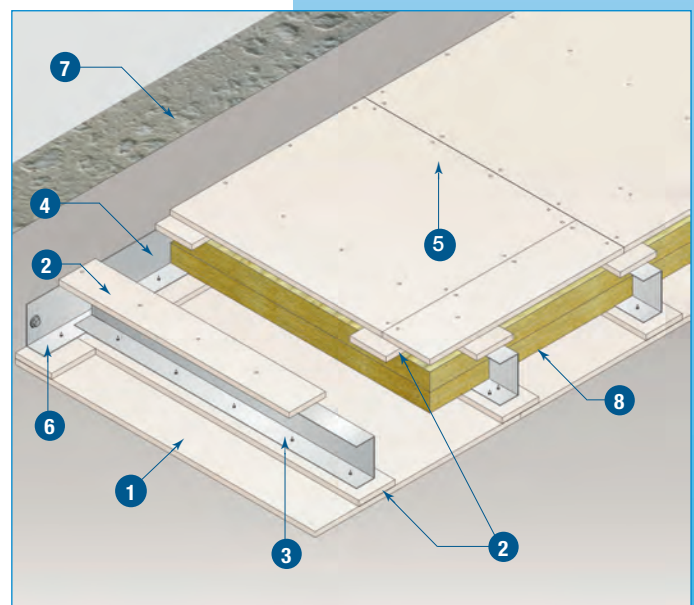
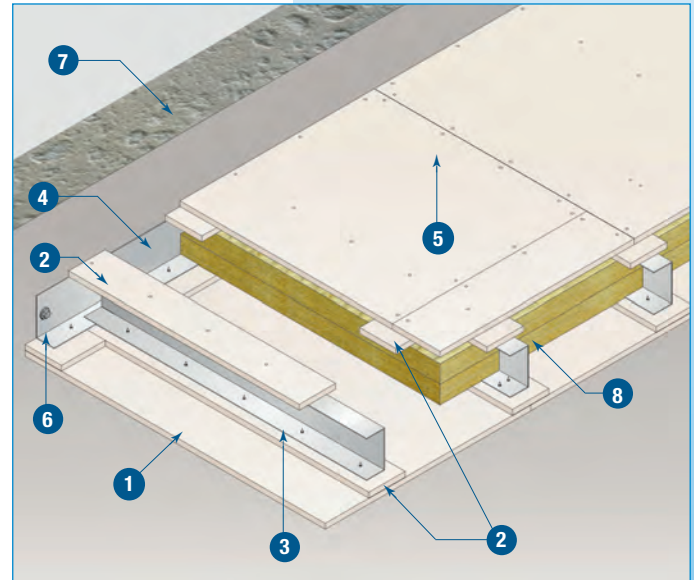

## Promat SUPALUX® Ceilings, Floors and Roofs

BFTC Report 0725

### Protected Zones, 60 minutes

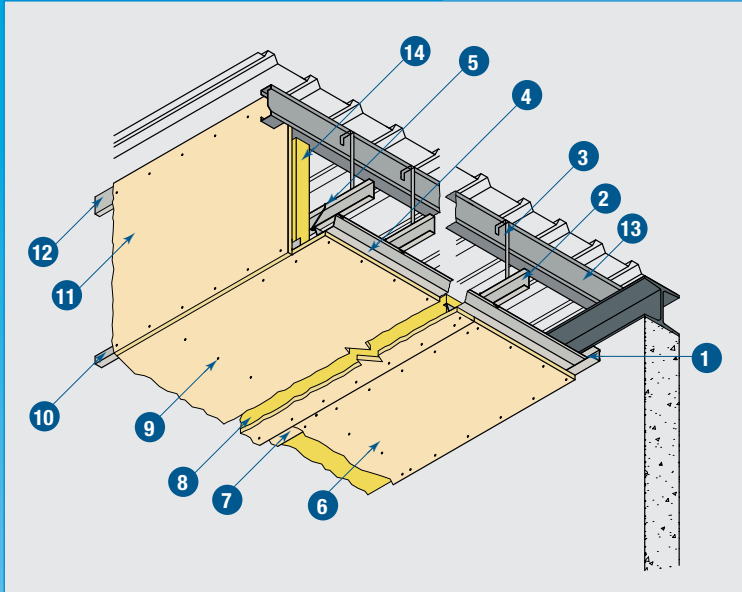

This control zone construction is only applicable to roof coverings that will not in themselves contribute to fire spread.

For confirmation of this, consult with the roof manufacturer.

1. MF6 perimeter channel (1) 20 x 28 x 30mm x 0.5mm, fixed to surrounding construction at 500mm centres using non-combustible screws or plugs and anchors (depending on element of construction).
2. MF7 primary support channel (2) 15 x 45 x 0.9mm thick suspended from purlins at max. 610mm centres using 25mm x 0.55mm thick MF8 strap hangers (3). MF7 channels rested on top flange of MF6 perimeter channel at 600 centres.
3. MF8 strap hangers (3) fixed to purlins using 38mm Ejoy Tec screws. Hangers fixed to MF7 primary grid system (2) using 32mm drywall screws.
4. MF5 ceiling sections (4) 80 x 26 x 0.5mm at max. 610mm centres on underside of primary grid, connecting to MF7 channel using MF9 connecting clips (5) and engaging into MF6 perimeter channel.
5. 9mm Promat SUPALUX® ceiling (6) fixed to MF5 channel using 25mm drywall screws at 200mm centres.
6. 9mm Promat SUPALUX® 100mm wide cover strips (7) fixed at transverse joints using 32mm drywall screws at 200mm centres, fixed on both sides of the joint.
7. Rock wool insulation (8) 50mm thick x minimum 35kg/m<sup>3</sup> laid over Promat SUPALUX® boards, insulation butted up to MF5 ceiling sections. The vertical rock wool (14) is retained in position using 1mm iron wire.
8. Vertical boards (1 layer of 9mm Promat SUPALUX®) (11), fixed to steel sections with 100mm wide cover strips at transverse joints. Boards cut to fit within purlin and fitted flush to underside of roof. Any gaps to be fire stopped with rock wool. Board fixed at base to angle fixed to MF5 section (10) and also at top to MF7 channel (12) spanning between, and fastened to the purlins. Maximum drop 600mm.
9. Purlins (13) at maximum 1.8m centres, supported by steel beam or on top of blockwork wall. Steel beams require boxing with minimum of 20mm Promat VERMICULUX® to provide required 60 minutes fire compartmentation and fire protection to the steel (omitted for clarity, contact Promat UK Technical Services for confirmation of board thickness required).
10. All gaps, abutments, air and smoke paths to be fire stopped, and sealed with Promat PROMASEAL® Intumescent Sealant.



## Promat SUPALUX® Ceilings, Floors and Roofs

### Protected Zones, 120 minutes

BFTC Report 0721

This control zone construction is only applicable to roof coverings that will not in themselves contribute to fire spread.

For confirmation of this, consult with the roof manufacturer.

1. MF6 perimeter channel **(1)** 20 x 28 x 30mm x 0.5mm, fixed to surrounding construction at 500mm centres using non-combustible screws or plugs and anchors (depending on element of construction).
2. MF7 primary support channel **(2)** 15 x 45 x 0.9mm thick suspended from purlins at max. 610mm centres using 25mm x 0.55mm thick MF8 strap hangers **(3)**. MF7 channels rested on top flange of MF6 perimeter channel at 600 centres.
3. MF8 strap hangers **(3)** fixed to purlins using 38mm Ejoy Tec screws. Hangers fixed to MF7 primary grid system **(2)** using 32mm drywall screws.
4. MF5 ceiling sections **(4)** 80 x 26 x 0.5mm at max. 610mm centres on underside of primary grid, connecting to MF7 channel using MF9 connecting clips **(5)** and engaging into MF6 perimeter channel.
5. 9mm Promat SUPALUX® ceiling **(6)**. First layer fixed to MF5 channel using 25mm drywall screws at 200mm centres.
6. 9mm Promat SUPALUX® ceiling **(7)**. Second layer fixed to MF5 grid system using 36mm drywall screws at 200mm centres **(8)**. Boards staggered by minimum 600mm centres. Second layer stitched to first layer at transverse joints **(9)** using 25mm drywall at 200mm centres.
7. Vertical boards (2 layers of 9mm Promat SUPALUX®) **(10)**, fixed to steel sections with joints staggered by minimum 600mm, boards cut to fit within purlin and fitted flush to underside of roof. Any gaps to be fire stopped with rock wool. Boards fixed at base to angle fixed to MF5 section **(11)** and are also at top to MF7 channel **(12)** spanning between, and fixed to, the purlins. Maximum drop 600mm.
8. Purlins **(13)** at maximum 1.8m centres, supported by steel beam or on top of blockwork wall. Steel beams require boxing with minimum of 30mm Promat VERMICULUX® to provide required 120 minutes fire compartmentation and fire protection to the steel (omitted for clarity, contact Promat UK Technical Services for confirmation of board thickness required).
9. All gaps, abutments, air and smoke paths to be fire stopped, and sealed with Promat PROMASEAL® Intumescent Sealant.

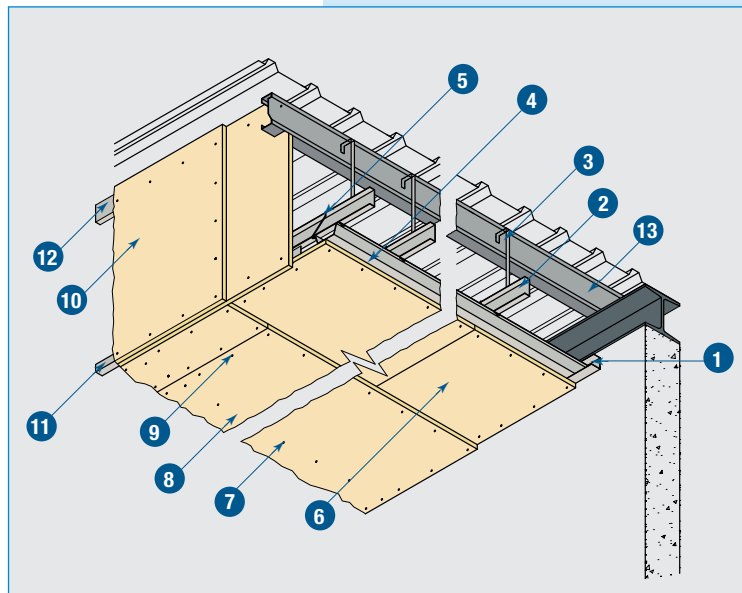

## Promat SUPALUX® External and Internal Walls

### Conversion of External Wall to Internal Wall, Concealed Grid System, 60 minutes

#### CONVERSION OF EXTERNAL WALL TO INTERNAL WALL, CONCEALED GRID SYSTEM

##### TECHNICAL DATA

60 minutes fire rating, integrity and insulation in accordance with the criteria of BS 476: Part 22: 1987.

Estimated sound insulation:  $R_w$  45-50dB based on 200mm deep sheeting rail

1. Horizontal sheeting rail at maximum 2.2m centres.
2. Promat SUPALUX® board, 9mm thick.
3. Promat SUPALUX® fillet, 9mm thick x depth of sheeting rail fixed to both faces of sheeting rails with M4 steel self-tapping screws at nominal 300mm centres.
4. Galvanised steel top hat sections, approximately 26mm deep x 50mm wide x 15mm lips x 0.6mm, at 600mm centres. Width of face that panels are screwed to should be 50mm minimum. Secure top hats to every rail using two M4 steel fixings per rail fixed through lips of section at each junction.
5. Perimeter galvanised angle, 25mm x 25mm x 0.6mm secured to wall or floor using steel screws or bolts, and plugs at nominal 500mm centres.
6. Rock wool quilt, minimum 100mm x 23 kg/m<sup>3</sup> or 80mm x 30kg/m<sup>3</sup> must be suspended between the sheeting rails. The rock wool can be secured to the underside of each rail using galvanised angle 50mm x 25mm x 0.5mm or similar, fastened with M4 self-tapping screws at maximum 300mm centres.
7. M4 x 19mm self-tapping screws, at nominal 300mm centres. Screw boards to every top hat section.
8. Promat SUPALUX® cover strips, 100mm wide at horizontal joints fixed using M4 self-tapping screws at nominal 300mm centres on both sides of joints.

**NOTE:** The specifications may vary slightly depending on the sheeting rail size. Any structural steel protruding from the Promat SUPALUX® lining should also be fire protected. For further details please contact Promat Technical Services Department.

#### CONVERSION OF EXTERNAL WALL TO INTERNAL WALL, EXPOSED GRID SYSTEM

##### TECHNICAL DATA

60 minutes fire rating, integrity and insulation in accordance with the criteria of BS 476: Part 22: 1987.

Estimated sound insulation:  $R_w$  45-50dB based on 200mm deep sheeting rail

1. Horizontal sheeting rail at maximum 2.2m centres.
2. Promat SUPALUX® board 9mm thick, 600mm wide to suit Promat FLAMEBRAKER™ Grid. Boards fitted into the main tees and retained by spring wedges, fitted into the pre-punched holes in stems of the main tees. Wedges fitted at 150mm nominal centres.
3. Promat SUPALUX® fillet, 9mm thick x depth of sheeting rail, fixed to both faces of sheeting rails, fixed with M4 steel self-tapping screws at nominal 300mm centres.
4. Promat FLAMEBRAKER™ Grid, main tees at 603mm centres, cross tees at all panel joints. Main tees suspended from sheeting rails with minimum 18mm wide x 0.8mm thick galvanised steel strips passing over sheeting rails (Promat FLAMEBRAKER™ Grid).
5. Perimeter angle of Promat FLAMEBRAKER™ Grid system, 25mm x 25mm x 0.6mm secured to wall or floor using steel screws or bolts, and plugs at nominal 500mm centres.
6. Rock wool quilt, minimum 100mm x 23 kg/m<sup>3</sup> or 80mm x 30kg/m<sup>3</sup> must be suspended between the sheeting rails. The rock wool can be secured to the underside of each rail using galvanised angle 50mm x 25mm x 0.5mm or similar, fastened with M4 self-tapping screws at maximum 300mm centres.

**NOTE:** The specifications may vary slightly depending on the sheeting rail size. Any structural steel protruding from the Promat SUPALUX® lining should also be fire protected. For further details please contact Promat Technical Services Department.

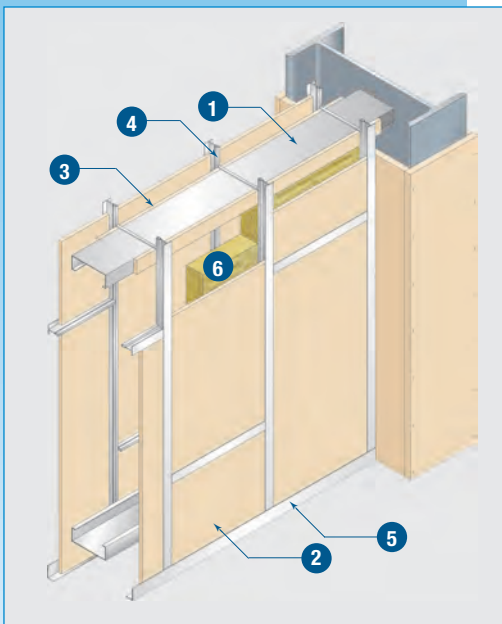
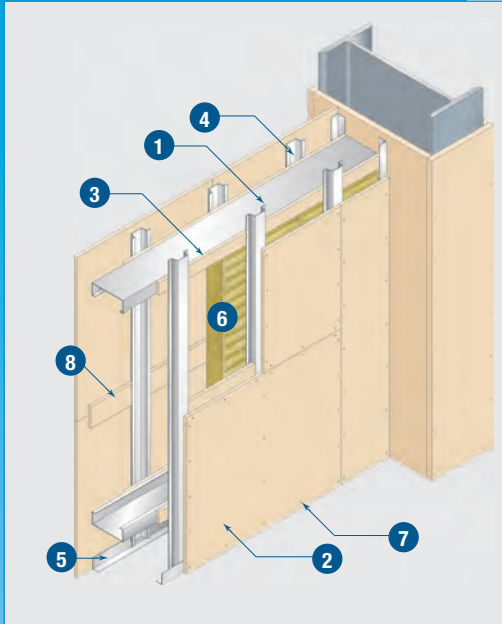



## Promat SUPALUX® External and Internal Walls

Further than 1m from the Relevant Boundary, Exposed Grid System, 60 minutes

Warrington Assessment No 169602

### EXTERNAL WALLS, FURTHER THAN 1M FROM THE RELEVANT BOUNDARY, EXPOSED GRID SYSTEM

#### TECHNICAL DATA

Estimated sound insulation:  $R_w$  43-50dB based on 200mm deep sheeting rail

60 minutes fire rating, integrity and 15 minutes insulation in accordance with the criteria of BS 476: Part 22: 1987 internal fire only.

1. Horizontal sheeting rail at maximum 2.2m centres.
2. External cladding, either single skin steel or fibre cement sheet (minimum Class 0 rating) fixed to sheeting rails with steel fixings.
3. Promat MASTERBOARD® 6mm thick x 600mm wide. Retained by spring wedges inserted in to pre-punched holes in the stems of the Promat FLAMEBRAKER™ Grid. Wedges fitted at 150mm nominal centres.
4. Vertical main tees at 603mm centres (Promat FLAMEBRAKER™ Grid).
5. Horizontal cross tees at every panel joint (Promat FLAMEBRAKER™ Grid).
6. Purlin straps (Promat FLAMEBRAKER™ Grid).
7. Galvanised perimeter angle, 25mm x 25mm x 0.6mm (Promat FLAMEBRAKER™ Grid).
8. Rock wool, minimum 60mm x 23kg/m<sup>3</sup>, suspended in cavity. Secure to underside of sheeting rails using galvanised angle, 50mm x 25mm x 0.5mm, or similar, fixed through the angle and rock wool to the rail using M4 steel self-tapping screws at maximum 300mm centres.

**NOTE:** This specification does not cover the use of composite cladding systems with combustible cores.

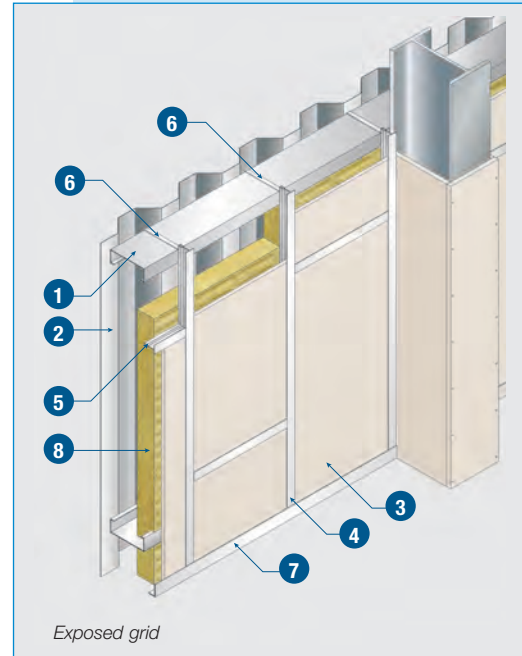

### EXTERNAL WALLS, WITHIN 1M FROM THE RELEVANT BOUNDARY

#### TECHNICAL DATA

60 minutes fire rating, integrity and insulation in accordance with the criteria of BS 476: Part 22: 1987 fire from either side.

Estimated sound insulation:  $R_w$  48-53dB based on 200mm deep sheeting rail

1. Horizontal sheeting rail at maximum 2.2m centres.
2. External cladding, single skin of steel, aluminium or fibre cement.
3. Promat SUPALUX® 9mm thick, screw fixed to main tees with M4 steel self-tapping screws at nominal 200mm centres.
4. Promat SUPALUX® 9mm thick x 600mm wide, retained by spring wedges inserted in to pre-punched holes in the stems of the Promat FLAMEBRAKER™ Grid. Wedges fitted at 150mm nominal centres.
5. Promat SUPALUX® fillet, 9mm thick x depth of sheeting rail, fixed to both faces of sheeting rail with M4 steel self-tapping screws at nominal 300mm centres.
6. Vertical main tees at 603mm centres (Promat FLAMEBRAKER™ Grid). Main tee suspended from sheeting rails with minimum 18mm wide x 0.8mm thick galvanised steel straps passing over sheeting rails.
7. Vertical main tees, 35mm x 35mm x 0.55mm on the external face are cut away around the sheeting rails.
8. Horizontal cross tees at every panel joint (Promat FLAMEBRAKER™ Grid).
9. Purlin strap (Promat FLAMEBRAKER™ Grid).
10. Galvanised perimeter angle, 25mm x 25mm x 0.6mm.
11. Rock wool, minimum 80mm x 23 kg/m<sup>3</sup>, should be suspended in cavity by fixing to the underside of sheeting rails and extending down past lower rails behind internal lining and fixed between the sheeting rails using galvanised angle, 50mm x 25mm x 0.5mm or similar, fixed through the angle and rock wool to the rail at maximum 300mm centres.

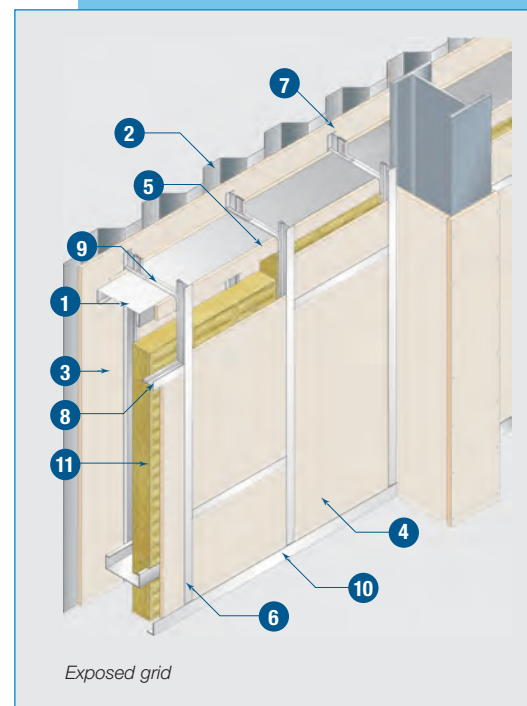

Certifire Approval No CF 420A

## Promat SUPALUX®

Working, Fixing, Decorating

### VERTICAL AND HORIZONTAL SERVICE ENCLOSURES - FIXING TO ANGLES

#### TECHNICAL DATA (1, 2, 3 and 4 SIDED ENCLOSURES)

##### Promat SUPALUX® Enclosures

Up to 240 minutes fire rating, integrity with various periods of insulation, in accordance with criteria of BS 476: Part 20: 1987 internal or external fire.

1. Promat SUPALUX®, thickness in accordance with table below.
2. Metal angle framing, consult Promat Technical Services Department.  
Minimum 30mm x 30mm x 0.8mm angles up to 50mm x 50mm x 1.2mm. Steel channel may be required.  
Additional framing may be required according to span and impact requirements of construction.
3. M4 screws at 250mm centres, screw length to provide minimum 10mm penetration through angle. Two or three sided casings: fix steel angles to suitable fire resisting wall or soffit using M4 screws into non-combustible plugs: screw length to provide minimum 30mm penetration into plugs.
4. Butt joints must have 75mm wide backing strip inside circumferential joints, if joint not backed by angle. Thickness of backing strip to be same as that required for board encasement.

Please contact Promat Technical Services for details of fixing for Promat service enclosures.

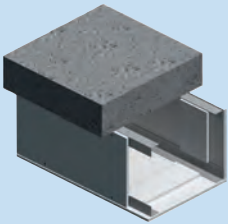
Vertical and Horizontal Service Enclosures – 1, 2 and 3 sided enclosures			
Angle fix method	Product	Fire Rating Stability/Integrity/Insulation	Maximum Size
	<b>Promat SUPALUX®</b> <ul style="list-style-type: none"> <li>● 9mm thick</li> <li>● 12mm thick</li> </ul>	120/120/- 240/240/-	1000mm x 800mm (additional framing required for spans over 600mm) <b>Assessment No. WF 169598</b>



# Promat SUPALUX®

## Working, Fixing, Decorating

### WORKING

#### Cutting

Promat boards can be cut with conventional wood working equipment although the use of hand saws with hardened teeth is recommended. Promat boards greater than 6mm in thickness may be more easily cut using a power circular saw with tungsten carbide tipped blades, or a jigsaw. For rough cutting, 6mm sheets can be deeply scribed and broken over a straight edge. Promat recommend that all cutting should be carried out in well ventilated spaces, using dust extractors. Operators should wear protective face masks.

#### Drilling

Use normal low or high speed drills. Place scrap board under drilling location for a clean hole.

#### Smoothing and Sanding

Smooth cut edges with a surform, plane, rasp or file. Sand with conventional papers. Garnet paper is best for fine sanding.

### FIXING

#### Nailing

The most economical method of fastening is to use pneumatic nailing and stapling equipment. Nails can be driven directly through boards, without pre-drilling, provided they are at least 12mm from the edge of the board, and the back face of the board is fully supported.

In areas of high humidity, galvanised nails should be used. Panel pins, oval or lost head nails should not be used. Nails should be located minimum 40mm from corners.

#### Screw Fixing

Pilot holes should be pre-drilled not less than 12mm from the edge of the boards and countersunk if required. Use self-drilling or self-tapping screws when securing boards to steel. For all other situations, dry wall screws e.g. Hilo are generally suitable.

Boards of thicknesses greater than 15mm can be edge screwed. Self-drilling or self-tapping screws are suitable. If edge screwing the board, minimum screw penetration should be 30mm. If screws do not have a deep thread, pilot holes should be drilled and care should be taken not to over tighten. Screws should be minimum 40mm from corners.

Screws at corners should be positioned at a distance equal to the board thickness from the corner, or a minimum of 40mm, whichever is the greater. Boards can be edge screwed or screwed face to face. Care should be taken not to overtighten screws. For best results using screws, variable speed electric screw drivers with a torque control have proven the most successful.

#### Butt Jointing

Boards can be simply butt jointed with sheets having square, bevelled or chamfered edges. If required, a filler may be used to finish joints before decoration. Adhesives are not required.



## Promat SUPALUX®

### Working, Fixing, Decorating



### HANDLING, STORAGE

Carry boards on edge, do not drop on corners. Store under or fully protected from weather on a flat base, clear of ground. Fully support boards across width at not more than 1m centres.

### DECORATING

Promat materials provide a surface ready to receive most forms of decoration. Where finishes such as wallpaper are to be used, application can be made easier by first sealing the board with a proprietary sealer or paint.

#### Plastering

All calcium silicate boards have a high suction and therefore it is generally difficult to apply gypsum plaster.

Plastering boards: If a skim coat is desired, apply a sealing coat of diluted universal primer/PVA (e.g. 1 part PVA and 5 parts water). Sealing coat should be allowed to dry thoroughly (approximately 24 hours). Apply bonding coat (3 parts PVA and 1 part water). Apply plaster skim (5mm thick) while the bonding coat is wet and tacky.

It is recommended that a small test area is plastered initially to ensure that the boards have been adequately sealed. It is advisable that self-adhesive or hessian scrim is applied over joints and internal angles. Paper scrim is not recommended.

**NOTE:** *The bonding agent and plaster manufacturers' recommendations should be followed at all times.*

#### Tiling

Promat SUPALUX® can be tiled with ceramic, marble, granite and natural stone tiles (maximum 30kg/m<sup>2</sup>). In order to tile successfully, the following guidelines must be followed:

Supports: Vertical timber supports (minimum 50mm x 50mm) or steel studs should be installed at a maximum 400mm centres and all board joints must be supported.

Board preparation and fixing: The minimum board thickness to be used should be 9mm. The board should be sealed on both faces with PVA or watered down tile adhesive and allowed to dry. Fix the boards, preferably with the back (textured) face outwards, to the supports at 200mm centres. The screws should be countersunk and corrosion resistant. The tiles should then be fixed using standard tile adhesive.

**PLEASE NOTE:** Do not use Promat SUPALUX® as a tile backer where it forms part of a fire resistant construction.

#### Painting

All coatings should be supplied by a reputable manufacturer and their recommendations regarding surface preparation, sealing and finish coat should be followed. Promat boards have an attractive, smooth finish but, if required, they can be painted with emulsion or oil based paints. With water based paints, a diluted first coat should be used. For oil based paints a suitable alkali resisting primer should be used. Vapour barriers may be formed by applying chlorinated rubber, epoxy resin or polyurethane paint.

#### Papering

Size to seal against suction and improve slip, then hang papers or vinyls in the normal way.



## Promat SUPALUX® Case Studies

### Fire Protection of Wind Posts and Thatched Roof Fire Test

#### FIRE PROTECTION OF WIND POSTS

Wind posts are a common way of providing lateral support to tall masonry walls. In situations where the walls are also required to provide fire resistance between two compartments (or at a boundary position), the fire protection applied to the wind posts must also maintain the fire separation across the wall construction at that point.

RHS and SHS steel sections are frequently used for wind posts and the openings in the fire resistant wall may be typically 40mm wider than the steel section itself; in order to accommodate the block ties. The wind post will normally require fire protection for the same fire resistance period as the supported separating wall.

Fire attack will normally be considered to occur from either face, but not from both faces simultaneously. Under these circumstances the thickness of Promat SUPALUX® required to maintain fire separation across the wall, will usually be greater than the thickness required simply to protect the steel alone. The actual thickness of Promat SUPALUX® required depending on number of factors. For further information regarding the protection of wind posts, please contact Promat Technical Services.

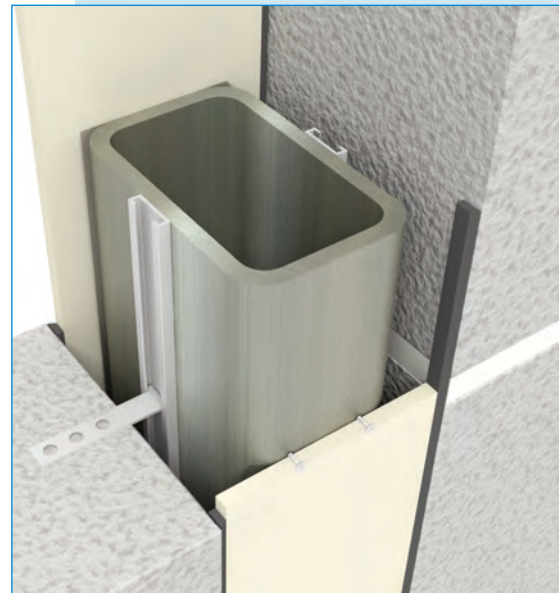

---

#### THATCHED ROOF FIRE TEST

On the 22 June 2006, Promat UK were at the filming of a thatched roof fire test, featured on the "Grand Designs" TV Programme.

The test was to show the benefits of the "Dorset Model" which includes the use of a "fire board" when installing a thatched roof. The board chosen for the test (and indeed the installation of thatch to the house featured in the programme) was Promat SUPALUX®.

The roof constructed from Promat SUPALUX® stood up to the fire, the water from the fire hoses and the aggressive methods used to rake the thatch from the roof to prevent fire spread. On inspection after the fire, the inside of the roof was completely untouched, with straw and wood shavings (from the construction) totally unscathed. A composite roof construction constructed without Promat SUPALUX® burned through in a matter of minutes, and eventually collapsed into a pile of smouldering cinders.



## Promat SUPALUX®

### Technical Data

*NOTE: All physical property values are averages based on standard production. The figures can change dependent on the test methods used. If a particular value is of prime importance for a specification, please contact Promat Technical Services Department.*

General Technical Data		
Designation	Calcium silicate	
Material class	Non-combustible	
Surface spread of flame	Class 1	
Building Regulations classification	Class 0	
Nominal dry density (average) kg/m <sup>3</sup>	950	
Alkalinity (approximately) pH	7-10	
Thermal conductivity (approximately) at 20°C W/mK	0.17	
Coefficient of expansion (20-100°C) m/mK	9 x 10 <sup>-6</sup>	
Nominal moisture content (ambient) %	6	
Moisture movement (ambient to saturated) %	≤ 0.1	
Thickness tolerance of standard boards (mm)	6-12mm ± 0.5 15-20mm ± 1.0 25mm ± 1.5	
Water vapour resistivity MNs/gm	98	
Length x Width tolerance of standard boards (mm)	± 3.0	
Surface condition	Front face	Smooth, unsanded
	Back face	Sanded

Board Format Data			
Thickness (mm)	Length x Width (mm)	Approx. Weight (kg/m <sup>2</sup> ),	
		Dry	With approximately 6% moisture
6	2440 x 1220	5.7	6.0
	2500 x 1200	5.7	6.0
9	2440 x 1220	8.6	9.1
	2500 x 1200	8.6	9.1
12	2440 x 1220	11.4	12.1
	2500 x 1200	11.4	12.1
15	2440 x 1220	14.3	15.1
	2500 x 1200	14.3	15.1
20	2500 x 1250	19.0	20.1
25	2500 x 1250	23.8	25.2

*NOTE: Bevelled edge ceiling tiles are also available. Other sizes are available upon request.*



## Promat SUPALUX®

### Technical Data

Mechanical Properties			
Flexural strength $F_{rupture}$	Average, dry	N/mm <sup>2</sup>	8.5
Modulus of elasticity E	Average, dry	N/mm <sup>2</sup>	6000
Tensile strength $T_{rupture}$	Average, dry	N/mm <sup>2</sup>	3.5
Compressive strength (perpendicular to board face)	Average, dry	N/mm <sup>2</sup>	6.0

### SAFETY SHEET

A safety data sheet is available from Promat Technical Services Department and, as with any other materials, should be read before working with the board. The board is not classified as a dangerous substance and so no special provisions are required regarding the carriage and disposal of the product to landfill. They can be placed in an on-site skip with other general building waste which should be disposed of by a registered contractor.

#### HEAD OFFICE, Belgium

Promat International NV  
Bormstraat 24  
BE-2830 Tisseelt  
Tel. +32 15 71 81 00  
Fax +32 15 71 81 09  
E-mail [info@promat-international.com](mailto:info@promat-international.com)  
[www.promat-international.com](http://www.promat-international.com)  
[www.promat-tunnel.com](http://www.promat-tunnel.com)  
[www.promat-marine.com](http://www.promat-marine.com)  
[www.promat-spray.com](http://www.promat-spray.com)

#### ASIA PACIFIC HEADQUARTERS Promat International (Asia Pacific) Ltd.

Unit 19-02-01, Level 2  
PNB Damansara  
No. 19 Lorong Dungun  
Damansara Heights  
MY-50490 Kuala Lumpur  
MALAYSIA  
Tel. +60 3 2095 8555  
Fax +60 3 2095 2111  
E-mail [info@promat-ap.com](mailto:info@promat-ap.com)  
[www.promat-ap.com](http://www.promat-ap.com)

#### AUSTRALIA

Promat Australia Pty Ltd.  
1 Scotland Road, Mile End  
AU- SA 5031 ADELAIDE  
Tel. +61 8 8352 6759  
Fax +61 8 8352 1014  
E-mail [mail@promat-ap.com](mailto:mail@promat-ap.com)  
[www.promat-ap.com](http://www.promat-ap.com)

#### AUSTRIA

Promat Ges.m.b.H.  
Seybelgasse 13  
AT-1230 WIEN  
Tel. +43 1 865 45 01  
Fax +43 1 865 36 00  
E-mail [office@promat.at](mailto:office@promat.at)  
[www.promat.at](http://www.promat.at)

Intumex GmbH  
Buchnerplatz 1  
4021 Linz

Tel: +43 70 6912 3767  
Fax: +43 70 6912 3740  
Email: [info@intumex.at](mailto:info@intumex.at)  
[www.intumex.at](http://www.intumex.at)

#### BELGIUM

Promat NV  
Kuiermansstraat 1  
BE-1880 KAPELLE-OP-DEN-BOS  
Tel. +32 15 71 33 51  
Fax +32 15 71 82 29  
E-mail [info@promat.be](mailto:info@promat.be)  
[www.promat.be](http://www.promat.be)

#### CHINA

Promat China Ltd.  
Room 503, Block B,  
Qi Lin PlazaHGI  
13-15 Pan Fu Road  
CN-510180 GUANGZHOU  
Tel. +86 20 8136 1167  
Fax +86 20 8136 1372  
E-mail [info@promat.com.cn](mailto:info@promat.com.cn)  
[www.promat.com.cn](http://www.promat.com.cn)

#### CZECHIA

Promat s.r.o.  
Ckalova 22/784  
CZ-160 00 PRAHA 6-BUBENEK  
Tel. +420 224 390 811  
Fax +420 233 333 576  
E-mail [promat@promatpraha.cz](mailto:promat@promatpraha.cz)  
[www.promatpraha.cz](http://www.promatpraha.cz)

Intumex s.r.o.  
U Rajské zahrady 3  
Praha 3  
130 00 Czechia  
Tel: +420 2241 06 227  
Fax: +420 2241 06 228  
E-mail: [intumex@intumex.cz](mailto:intumex@intumex.cz)  
[www.intumex.cz](http://www.intumex.cz)

#### FRANCE

Promat S.A.S.  
rue de l'Amandier B.P. 66  
FR-78540 VERNOUILLET  
Tel. +33 1 39 79 61 60  
Fax +33 1 39 71 16 60  
E-mail: [info@promat.fr](mailto:info@promat.fr)  
[www.promat.fr](http://www.promat.fr)

#### GERMANY

Promat GmbH  
Scheifenkamp 16  
DE-40878 RATINGEN 1  
Tel. +49 21 02 49 30  
Fax +49 21 02 49 31 11  
E-mail [mail@promat.de](mailto:mail@promat.de)  
[www.promat.de](http://www.promat.de)

#### GREAT BRITAIN

Promat UK Limited  
The Sterling Centre  
Eastern Road, Bracknell  
Berkshire RG12 2TD  
Tel. +44 1344 381 300  
Fax +44 1344 381 301  
E-mail: [salesuk@promat.co.uk](mailto:salesuk@promat.co.uk)  
[www.promat.co.uk](http://www.promat.co.uk)

#### HONG KONG

Promat International  
(Asia Pacific) Ltd.  
Room 1010, C.C.Wu Building  
302-308 Hennessy Road  
HK-WANCHAI  
Tel. +852 2836 3692  
Fax +852 2834 4313  
E-mail [apromath@promat.com.hk](mailto:apromath@promat.com.hk)  
[www.promat-ap.com](http://www.promat-ap.com)

#### INDIA

Promat Int. (Asia Pac.) Ltd.  
India Representative Office  
610-611, Ansul Imperial Tower  
C-Block, Community Centre  
Naraina Vihar, Naraina  
110028 NEW DELHI  
Tel. +91 11 2577 8413  
Fax +91 11 2477 8414  
E-mail [info-india@promat-asia.com](mailto:info-india@promat-asia.com)  
[www.promat-ap.com](http://www.promat-ap.com)

#### IIRELAND

43 Fitzwilliam Square,  
DUBLIN 2  
Tel: +353 1 676 5778  
[www.promat.ie](http://www.promat.ie)

#### ITALY

Promat S.p.A.  
Corso Paganini 39/3  
16125 GENOVA  
Tel: +39 010 24 88 411  
Fax: +39 010 21 37 68  
E-mail [info@promat.it](mailto:info@promat.it)  
[www.promat.it](http://www.promat.it)

Comais s.r.l.  
Via Provinciale 10  
24040 Filago (BG)  
Tel: +39 035 993 737  
Fax: +39 035 99 4240  
Email: [info@comais.it](mailto:info@comais.it)  
[www.comais.it](http://www.comais.it)

#### The NETHERLANDS

Promat B.V.  
Vleugelboot 22  
3991 CL HOUTEN  
PO Box 40385  
3504 AD UTRECHT  
Tel: +31 30 241 0770  
Fax: +31 30 241 0771  
E-mail [info@promat.nl](mailto:info@promat.nl)  
[www.promat.nl](http://www.promat.nl)

#### POLAND

Promat TOP Sp.oz.o  
Ul. Przeclawska 8  
PL-03-893 WARSZAWA  
Tel. +48 22 212 2280  
Fax +48 22 212 2290  
E-mail [top@promatop.pl](mailto:top@promatop.pl)  
[www.promatop.pl](http://www.promatop.pl)

#### RUSSIA

Promat GmbH  
Repräsentanz  
ul. Kantemirovskaya 58  
RU-115477 MOSCOW  
Tel. +7 095 325 42 68  
Fax +7 095 231 79 77  
E-mail [gd@promat.ru](mailto:gd@promat.ru)  
[www.promat.ru](http://www.promat.ru)

#### SINGAPORE

Promat Building System Pte Ltd.  
10 Science Park Road #03-14  
The Alpha,  
Singapore Science Park II  
SG-117684 SINGAPORE  
Tel. +65 6776 7635  
Fax +65 6776 7624  
E-mail [info@promat.com.sg](mailto:info@promat.com.sg)  
[www.promat-ap.com](http://www.promat-ap.com)

#### SPAIN

Promat Ibérica S.A.  
C/ Velazquez, 41 – 2 Planta  
ES-28001 MADRID  
Tel. +34 91 781 15 50  
Fax +34 91 575 15 97  
E-mail [info@promatiber.es](mailto:info@promatiber.es)  
[www.promatiber.es](http://www.promatiber.es)

#### SWITZERLAND

Promat AG  
Stationsstrasse 1  
CH-8545 RICKENBACH-SULZ  
Tel. +41 52 320 94 00  
Fax +41 52 320 94 02  
E-mail [office@promat.ch](mailto:office@promat.ch)  
[www.promat.ch](http://www.promat.ch)

#### UNITED ARAB EMIRATES

Promat Middle East  
Suite 1805  
18th Floor  
Dubai Festival City Tower  
PO Box 123945  
Dubai  
UAE  
Tel: + 971 4 232 9780  
Fax: + 971 4 232 9781  
E-mail: [promatmiddleeast@promat.co.uk](mailto:promatmiddleeast@promat.co.uk)  
[www.promat.co.uk](http://www.promat.co.uk)

#### VIETNAM

Promat Int. (Asia Pacific) Ltd.  
Vietnam Representative Office  
Room 606 Giay Viet Plaza  
180-182 Ly Chinh Thang Street  
Ward 9, District 3, Hochiminh City  
Tel/Fax: +84 (8) 931 5964  
E-mail: [phuong@promat-asia.com](mailto:phuong@promat-asia.com)  
[www.promat-ap.com](http://www.promat-ap.com)

# Promat



Promat UK Limited

The Sterling Centre, Eastern Road, Bracknell, Berkshire RG12 2TD  
Telephone: 01344 381 300 Fax: 01344 381 301 [www.promat.co.uk](http://www.promat.co.uk)

